

A Times Group publication

ULTIMATE GUIDE TO PROFITABLE MANUFACTURING

THE MACHINIST

RNI No 71129/98

Volume 17 Issue 9 • September 2022 • Rs 75

www.themachinist.in



THE LEADING LADY OF ELECTRIC!

In a chat with **Suman Mishra**, CEO, Mahindra Electric Mobility, wherein she divulges into her journey, MEML business, future plans and more.

THE EV RAGE

An in-depth look into the EV market, the short falls and more

EVENT REPORT

The Economic Time Promising Plants 2022



Narrow Parting for Cost Savings!

SWISSGRIP
N A R R O W W I D T H S

Innovative Tool Holder with a **2 Pocket Blade** for Parting and Grooving. Narrow Widths of **0.6-1.2 mm**. Fits Swiss-Type Machines. Easy and Fast Blade Indexing with **No Setup Time**.



High Cost Savings
No Setup Time

- 0.6 and 0.8 Insert Widths for 10 mm Part Diameter.
 - 1.0 and 1.2 Insert Widths for 16 mm Part Diameter.
- Increments of 0.2 mm**



Easy and Fast Blade Indexing from Either Side of the Tool



NEOLOGIQ
MACHINING INTELLIGENTLY

Member IMC Group
iscar
www.iscar.com



AEROSPACE



ENERGY



DEFENCE



INFRASTRUCTURE



HEALTHCARE



TEXTILE



OIL & GAS



PUMPS & VALVES

THE ECONOMIC TIMES



AUTOMOBILE



Tachyon 7

CNC High Speed Vertical Drill Tap Centre



ATM 160

CNC Inverted Vertical Spindle Turn Mill Centre



TMX 200

CNC Twin Spindle Twin Turret with Y-Axis



VTL 750

CNC Vertical Turret Lathe



HX Series

CNC Horizontal Machining Centre



HSX Series

CNC High Speed Horizontal Machining Centre

JYOTI CNC AUTOMATION LTD.

G – 506, G.I.D.C. Lodhika, Village : Metoda, Dist : Rajkot – 360021, Gujarat (INDIA).

T + 91-2827-235100/101, E info@jyoti.co.in, sales@jyoti.co.in jyoti.co.in

 JyotiHuron



ALL EYES ON INDIA

India's GDP growth in Q1FY23 was 13.5 per cent. At this rate, India is likely to be the fastest growing economy in the current fiscal. Interestingly, even as estimates of India's GDP growth rate for FY23 currently range from 6.7 to 7.7 per cent, a report by the State Bank of India firmly believes that it is immaterial. In a world that is ravaged by uncertainties, the report believes 6 to 6.5 per cent growth is the new normal.

Meanwhile, India has undergone a large structural shift since 2014 and is now the fifth largest economy. Interestingly, India surpassed the UK as the fifth largest economy as early as December 2021 itself and not recently as is being claimed. The share of India's GDP is now at 3.5 per cent, as against 2.6 per cent in 2014 and is likely to cross 4 per cent in 2027, the current share of Germany in global GDP! The path taken by India since 2014 reveals India is likely to get the tag of third largest economy in 2029, a movement of seven places upwards since 2014 when India was ranked 10th. India should surpass Germany in 2027 and most likely Japan by 2029 at the current rate of growth. This is a remarkable achievement by any standards.

In the coming days, India is likely to be the beneficiary as China slows down in terms of new investment intentions. Global tech major, Apple's recent decision to shift part production of its flagship iPhone 14 model for worldwide shipping from India, with a negligible time lag of a few weeks posts its slated launch in September, bears testimony to such optimism! The move by Apple, the most recognisable face of tech-infused innovation in the last two centuries, that captures aspirations of an upwardly mobile population should open the floodgates for other major conglomerates to follow suit.

A broad-based growth of empowerment will also lift India's per capita income from current levels and this could also as a force multiplier for a better tomorrow. At the beginning of the 21st century, China embarked on an accelerated growth path occupying the second largest economy tag. We believe, with the right policy perspective and realignment in global geopolitics our current estimates might even undergo an upward revision!

R Kamat
Editor

ADVISORY BOARD

Abhimanyu Bharthwal
Director, Oemeta India
Arundhati Thomas
Managing Director, Plazma Technologies

Bhaskar Maddala
CEO - Group Digital AI, JBM Group

Bipul Chandra
Managing Director, Ducati India

Diego Graffi
Managing Director and CEO, Piaggio

Dr. Rishi Mohan Bhatnagar
President - Aeris Communications India

Hrishikesh Kulkarni
COO, Zimmer Automation

K Krishnamoorthy
CEO & President, IESA

Krishnan Sadagopan
Sr VP, Ashok Leyland and Independent Director Indian Oil

Mahesh Babu
Director & CEO - Switch Mobility, India, and COO - Switch Mobility Ltd

Navid Talib
President & Chief Operating Officer Hero ECycles
(A Hero Motors Company)

Rajiv Bajaj
Managing Director - India and SEA, Stratays

Sagar Bhosale
Managing Director, Schmersal India

Senator Dr. PKC Bose
Vice Chairman & Managing Director, Enercon WindEnergy

Sudhir Gurtoo
Managing Director, Leadeed India

Vijay Pankhawala
Deputy Director, ARAI

Vinod Kumar Wuthoo
President, Indian SME Forum

Vinod Mittal
Chairman, Ispat Corp & Founder Avan Motors

Vivek Vikram Singh
MD and Group CEO, Sona Comstar

THE ULTIMATE GUIDE TO PROFITABLE MANUFACTURING
MACHINIST
Volume 17 Issue 9 September 2022



Chief Executive Officer **Deepak Lamba**

Chief Financial Officer **Subramaniam S**

Head Human Resource **Meghna Puthawala**

Vice President Marketing **Vidyut Patara**

Brand Publisher **Rishi Sutrave**
rishi.sutrave@wmm.co.in
+91 9820580009

Corporate Strategy and Subscriptions Lead **Ritika Masand**
ritika.masand@wmm.co.in

Editor **Rahul Kamat**
rahul.kamat@wmm.co.in
+91 9892612075

Assistant Editor **Anvita Pillai**
anvita.pillai@wmm.co.in
+91 9820137351

Associate Art Director **Sanjay Dalvi**
sanjay.dalvi@wmm.co.in

Executive Delegate Acquisition **Shruti Nair**
shruti.nair@wmm.co.in

ADVERTISING

West & North **Ranjan Haldar**
ranjan.haldar@wmm.co.in
+91 9167267474

South **Mahadev B**
mahadev.b@wmm.co.in
+91 9448483475

CAREERS
careers@wmm.co.in

SUBSCRIPTIONS
subscriptions.wmm@wmm.co.in

Printed and published by Sunil Wuthoo for and on behalf of owners Worldwide Media Pvt Ltd (CIN:U22120MH2003PTC142239), The Times of India Building, Dr DN Road, Mumbai 400001. Printed at Print Plus Pvt Ltd, 212, Swastik Chambers, ST Road, Chembur, Mumbai- 400 071.
Editor: Rahul Kamat. Published for September 2022.

Disclaimer: All rights reserved worldwide. Reproducing or transmitting in any manner without prior written permission prohibited. All photographs, unless otherwise specified, are used for illustrative purposes only. The publisher makes every effort to ensure that the magazine's contents are correct. However, we accept no responsibility for any errors or omissions and accept no responsibility for any loss or damage caused as an effect thereof. The information provided in this publication is for general use and may not be appropriate for the specific requirements and / or conditions of the reader/s. The opinions expressed by experts are their own and in no way reflect those of the publisher.



CASTROL ON MARS

CHOOSE LIQUID ENGINEERING CHOSEN BY NASA

THE SAME INNOVATION THAT HELPS NASA EXPLORE SPACE CAN BE FOUND IN EVERYTHING WE DO ON EARTH.



Find out more about our lubricants
solutions for industrial applications.

IT'S MORE THAN JUST OIL.
IT'S LIQUID ENGINEERING.



CONTENTS



COVER STORY

The Leading Lady Of Electric!..... **26**



EVS IN INDIA

Scaling India's Battery Ecosystem: Crucial Next Steps **31**

Editorial	4
News	8
Start-up Talk: Nemin Vora , Chief Executive Officer, Odysse Electric Vehicles.....	12
Industry Interview: Ravi Raghavan , President, IMTMA.....	14
Tech-It-Out: Virtual Commissioning – Entry To Model-Based Design & Springboard To Smart Industry	24
Event Report: Economic Times Promising Plants 2022: Recognising Factories Of Tomorrow Document Transformation	41
Products	45



Automotive Digitalisation

On Cloud: Accelerating Innovation
& Collaboration In Automotive
Industry **17**

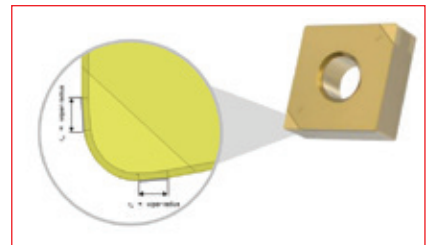

Tooling & Milling

Choosing Hard Part Turning As
Alternative To Grinding **20**



EV On-road

Melting ICE For
EV Momentum..... **34**



Automotive Technology

Future Outlook Of In-Car
Infotainment System Market -- **39**

Solid Carbide Drills
WSTAR Drill Series

MVS

NEW GENERATION SOLID CARBIDE DRILLS WITH NEW TRI-COOLING TECHNOLOGY

Coated Grade DP1020

Offers excellent wear resistance and reduced friction for longer tool life and a versatile range of applications.

New Type Thinning

Large chip pocket near center of drill.
Low thrust force.

Wavy Cutting Edge

High cutting edge strength and ideal chip control.
Deep hole cutting with high efficiency.

TRI-cooling Technology[®]

Improved cooling effect and chip removal.

New Flute Shape

Ideal web thickness and helix angle.

Double Margin

Provides excellent straightness and surface finish.

Zero- μ -Surface

Reduces cutting resistance and offers excellent chip evacuation.

Straight Cutting Edge

Improved chip evacuation and enhanced cutting edge strength.

New Flute Geometry

For improved chip evacuation.

LONG TOOL LIFE FOR WIDE RANGE
OF APPLICATIONS

L/D=2 is available for pilot holes

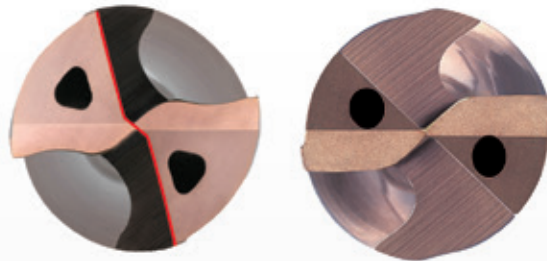

Long Type

DC x 10, 15, 20, 25, 30, 35, 40

High efficiency drilling hole with
2000mm/min feed rate or higher.
(\varnothing 5mm, DC x 30, Case with
drilling in steel)

Small Dia \varnothing 1mm - \varnothing 2.9mm,

Ideal for long tool life and
process security when
deep hole drilling.



MMC Hardmetal India Pvt. Ltd.
A Subsidiary of MITSUBISHI MATERIALS

Tel : +91 80 2204 3600 - 2204 3699
Website : www.mitsubishicarbide.com
Email : mmcindia@mmc.co.jp



YOUR GLOBAL CRAFTSMAN STUDIO

Alstom's Mumbai Metro Line 3 Successfully Flagged For Trail Run

MUMBAI METRO RAIL CORPORATION LIMITED (MMRCL) successfully conducted trail run of the first trainset delivered by Alstom for the Mumbai's Colaba-Bandra-Seepz Metro line 3 (Aqua Line). It is the city's first metro project that can run driverless having 75 per cent motorisation, making operations efficient. It is also the city's first fully underground metro project.

The metro trainset was flagged off for trial runs by CM of Maharashtra, Eknath Shinde and Deputy CM, Maharashtra, Devendra Fadnavis, along with Ashwini Bhide, Managing Director, MMRC. The metro trainset ran a three-kilometre stretch from Sariput Nagar, Aarey, to Marol Naka for the inaugural trial run.

Alstom is indigenously designing, manufacturing, and commissioning 31 lightweight, fully furnished modern passenger train sets of eight cars each (248 metro cars) for the 33.5-km long



underground stretch of Mumbai Metro Line 3. This is the biggest rolling stock contract in India's urban mobility sector for the company, valued at approximately €315 million. Making it an easy travel for Mumbaiikars, these metro trains are estimated to reduce 35 per cent of overall traffic and help in reducing air & noise pollution.

With a proven track record, low lifecycle costs and keen focus on passenger experience, Alstom's Metropolis trainsets set the standard in energy-

efficient, and safe operations. Themed on 'Dynamic Fluidism' that takes inspiration from the city, these trains prioritise high interior density layout to maximise space efficiency, enabling each trainset to carry 3,000 passengers per trip. These metro trains are a testament to the company's superior eco-design principle, with 96 per cent of the mass of materials and components used being recyclable, and 99 per cent recoverable.

Mumbai Metro Line 3 will connect Cuffe Parade business district in the extreme south of the city to Seepz in the north-central with 26 underground and one street-level station. Alstom is also equipping this line with the latest generation of CBTC signalling technology (Urbalis 400). This is Alstom's proprietary technology that results in increasing average capacity by 30 per cent in manned services and unattended train operations (UTO) and helps reduce energy consumption by 30 per cent.

ATS Elgi Announces Manufacturing Agreement With VTEQ, Spain

ATS ELGI, a wholly owned subsidiary of Elgi Equipments Limited and India's largest garage equipment manufacturer, announced its manufacturing agreement with VTEQ, a global leader in vehicle testing equipment based out of Spain. With this partnership, ATS ELGI will set up a world-class 7500 square feet manufacturing facility to manufacture previously imported vehicle testing equipment for the Indian market at competitive prices. The equipment spans brake, suspension, slip, and speedo testers, axle play detectors, and steering gear play.

Commenting on the partnership, Praveen Tiwari, Managing Director, ATS ELGI Ltd., said, "We are excited to embark on this new journey with VTEQ. We have been maintaining VTEQ vehicle testing equipment in India for Government-run testing centres for over five years as a natural extension of our association with them. For several years, all of these products were imported into the country. With this breakthrough

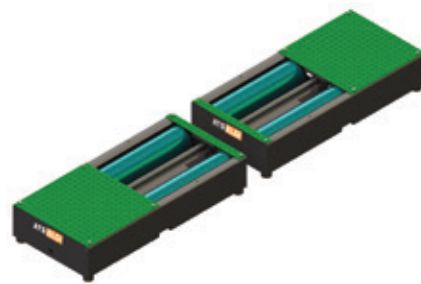
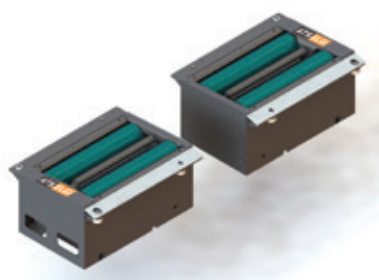

agreement, we will now manufacture proven products in the country and offer them to customers at affordable prices. In addition, ATS ELGI's widespread sales and service network will ensure customers have access to faster procurement of equipment, high uptime, and quick response rates for addressing maintenance and spare parts requirements."

"India was the fifth-largest car market in 2020, and the country's automotive sector, including components, is expected to be worth INR 16.1-18.1 trillion by 2026. We're also witnessing the Indian

government introducing key initiatives - the Faster Adoption and Manufacturing of Hybrid & Electric Vehicles (FAME), the National Automotive Testing and R&D Infrastructure Project (NATRIP), and the Bharat Stage (BS) VI standards to promote the country's automobile production and testing. Over the next five years, we expect over 200 testing centres will be set up in the country. We are looking forward to our partnership with VTEQ, which will provide us with an excellent growth opportunity," added Dr Jairam Varadaraj, Managing Director, Elgi Equipments Ltd.

ElectronEV To Roll Out Light/ Medium & Heavy Commercial Vehicles In India



US-BASED ELECTRONEV has announced its foray into India to roll out light/ medium and heavy commercial

vehicles. With a substantial fleet of over 500 commercial EVs running in the US, the brand is introducing its unique services, including customised EV vehicles, vehicle management solutions, fleet management solutions, digital cockpit and IoT solutions, real-time data analytic solutions, and charging infrastructure to the fast-growing Indian market.

With this, ElectronEV plans to introduce its proprietary EV technology through its electric vehicles and end-to-end mobility solutions for markets like India, Southeast Asia, Australia and Europe. The product portfolio will consist of light, medium, and heavy-duty commercial vehicles like delivery vans, trucks, and buses.

The company is planning to target the pain areas like the limitations of the battery technology, high capital expendi-

ture, price of electric vehicles, availability of charging infrastructure, time taken to fully charge an electric vehicle through its smart, modular, heavy-duty battery with intelligent adaptive chassis and software-driven powertrain.

To provide higher production volumes closer to target customers, ElectronEV will adopt a manufacturing strategy of setting up micro-factories in conjunction with a modular technology stack.

Rakesh Koneru, Founder, ElectronEV, said, "India is emerging as the largest and fastest growing market for EVs. That is why our products will cater to the demand for B2B and B2C segments in India. ElectronEV plans to introduce its proprietary EV technology through its electric vehicles and end-to-end mobility solutions for markets like India, South East Asia, Australia, and Europe."

Godrej Material Handling Aims 30 Per Cent Revenue From Telangana

GODREJ & BOYCE, the flagship company of the Godrej Group, announced that its business Godrej Material Handling has projected 15 per cent business growth in Telangana. The business showcased its recently launched forklift trucks including 3 Wheel Bravo Electric Forklift and Godrej PRO Series Reach Truck for the first time in Hyderabad.

The city's e-commerce, retail, and pharma companies are key drivers of the warehousing demand in Hyderabad. Retail and e-commerce companies either prefer to manage their operations or outsource their logistics and warehousing operations to third-party logistics (3PL) players and equipment rental providers. This has led to an increase in demand for battery-operated equipment which can work in narrow aisles and can stack vertically up to 12m. Thus, the demand for this equipment has increased in the state. With technologically advanced innovations, Godrej Material Handling aims to achieve 30 per cent of revenue in FY23 with an aspiration to achieve 50 per cent of revenue in the next three years.

In the warehouse equipment category, there has been a discernible shift toward equipment with cleaner, greener, and smarter technologies. Aligned with the company's motto to contribute toward India's self-reliance, the two recently launched forklift trucks exhibited by Godrej Material Handling in Hyderabad have been indigenously designed to be a workhorse to increase throughput. The Bravo Electric Series has twin motor technology and is modern equipment that drives productivity in demanding applications and narrow spaces with its easier-to-operate machinery that is also safer for the environment. The Godrej PRO Series Reach Truck can work two shifts with a single higher capacity battery and thus ensures an increase in



safety at the workplace.

Godrej Material Handling is the only Indian player to offer wet disc brakes that are present in the Bravo Electric Forklift series. They are the most advanced and safe braking systems with lesser braking effort resulting in shorter stopping distance ensuring workplace safety. This advanced piece of machinery is easier to operate, safer for the environment and moves quietly across the workspace. Godrej PRO Series Reach Truck can lift to 12 metres and its new frame design & best-in-class turning performance enables the PRO Reach Trucks to work in aisles as narrow as 2.6 metres.

LVD Brings Smart Factory To Life At EuroBLECH

LVD puts the focus on smart manufacturing showcasing interconnected sheet metal fabrication processes at EuroBLECH, Hall 12 – Stand F104 with the theme of ‘Shaping Flows’. On display will be a Smart Factory cell as well as the latest laser cutting, bending, combination equipment, software and automation, demonstrating flexible solutions to enable a smarter production environment.

The cost-effective smart cell brings to life a smart factory driven by cost-efficient machinery comprised of the LVD YSD LaserONE laser cutting machine, a basic, no-frills fibre laser, LVD Dyna-Cell robotic bending cell for small- to medium-sized parts and CADMAN software.

Dyna-Cell is bending automation at a fraction of the cost of traditional robotic bending systems. Designed to keep the cost per part low, Dyna-Cell is priced less than the cost of two stand-alone press brakes. It is easily programmed, fully offline, in 20 minutes or less with 10 minutes of program preparation, 10 minutes of tool set-up



and first part production.

The high-power 20 kW Phoenix FL-3015 processes a range of materials in thicknesses up to 40 mm. The 20-kW machine cuts up to 2.5 times faster than a 10-kW fibre laser. It pierces and cuts thick materials at rates faster than most plasma cutting systems.

The Ulti-Form robotic bending system handles small batch and long production runs with equal efficiency, delivering high productivity and consistent bending accuracy. Ulti-Form

offers a fast ‘art to part’ process. CADMAN-B software automatically calculates the optimal bend program and imports bending data to the robot software CADMAN-SIM – no robot teaching is required. SIM automatically calculates gripper positions, generating the fastest collision-free path for the robot, and relays the information back to B, enabling the operator to work with a single program.

The Strippit Punch-Laser combines the punching and forming advantages of the Strippit V Series punch press with the speed and versatility of fibre laser cutting to complete multiple processes on a single machine, answering the need for flexible manufacturing.

The new Dyna-Press 60/20 electric drive press brake offers 60 tons of pressing force and 2 meters of bending length for the most capacity of any Dyna-Press machine.

LVD continues to drive a smarter factory with its integration philosophy and a complete suite of CADMAN® software products all designed to shape process flow.

MG Motor India Introduces The ‘Advanced Gloster’

MG MOTOR INDIA announced the launch of the Advanced Gloster starting at Rs 31.99 lakh. India’s first autonomous (Level 1) premium SUV now comes with new and advanced safety, style, and technology enhancements.

The existing Gloster’s Advanced Driver Assist System (ADAS) has additional first-in-segment features such as Door Open Warning (DOW), Rear Cross Traffic Alert (RCTA), and Lane Change Assist (LCA).

The towering road presence of the Advanced Gloster is further strengthened by the all-new British Windmill Turbine-themed alloy wheels in 4WD variants. The ‘Advanced Gloster’ offers entertainment on the go and retains its Best-in-Segment 31.2 cm touchscreen and high-quality audio system with 12 speakers along with Android Auto and Apple Car Play including the first-in-segment Shortpedia News App and

Gaana song search via voice commands. The SUV ups the ante with its upgraded and smart-tech inclusion of more than 75 Connected Car features.

Available in 2WD and 4WD with six- and seven-seater options the ‘Advanced Gloster’ brings with it unmatched premium luxury and best-in-class interior space. The ‘Advanced Gloster’ keeps the powerful 2.0-litre diesel engine which is available in two choices including a first-in-segment twin-turbo diesel engine producing 58.5 kW power.

It comes with best-in-class features, a towering road presence, a powerful capability, and luxurious interiors. The SUV possesses an intelligent 4WD, an all-terrain system with 7 modes, a dual panoramic electric sunroof, a 12-way power adjustable driver seat, driver



seat massage and ventilation feature, and wireless charging, among its many noteworthy features.

The Advanced Gloster will also offer a personalized car ownership program ‘My MG Shield’ with over 180 after-sales service options. Also, customers will be offered a standard 3+3+3 package i.e., a warranty of three years of unlimited kilometres, three years of roadside assistance and three labour-free periodic services.

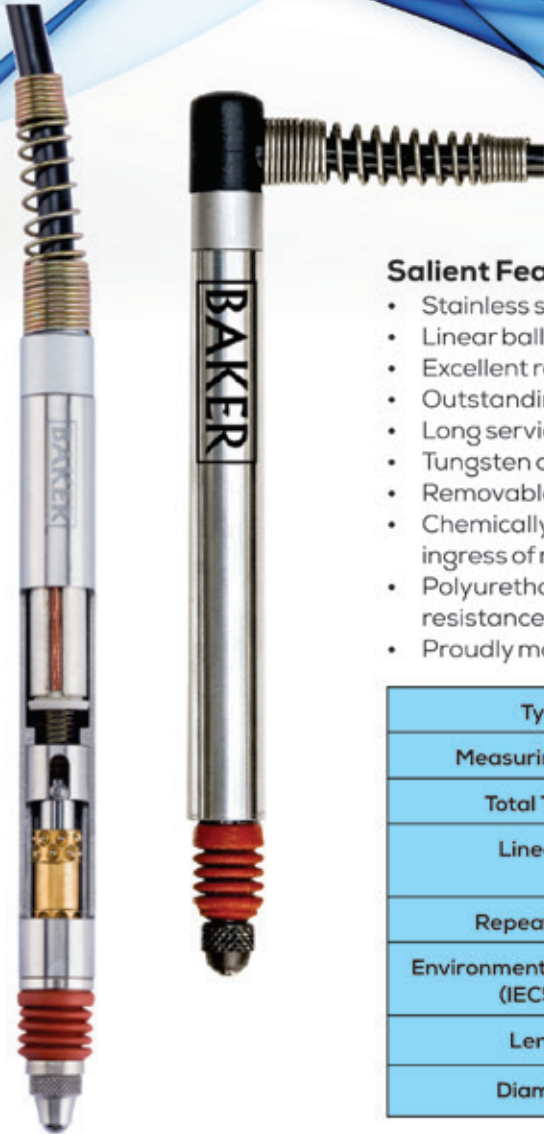

Salient Features

- Stainless steel body, hardened to 55HRC
- Linear ball-bearing guide for plunger and core
- Excellent repeatability
- Outstanding linearity
- Long service life and reliability
- Tungsten carbide ball tip
- Removable tip permits choice of special purpose tips
- Chemically inert and non degradable Viton rubber bellow prevents ingress of moisture and dust
- Polyurethane cable for long-term oil resistance, as well as superior resistance to abrasion and cuts.
- Proudly made in India

Type	2920	2940	2910	2900
Measuring Travel	± 1 mm	± 2 mm	± 0.5 mm	± 0.3 mm
Total Travel	3 mm	4.5 mm	2.25 mm	1 mm
Linearity	± 0.3 %	± 0.3 % (in ± 1 mm range)	± 0.3 %	± 0.5 %
Repeatability	0.02 µm	0.02 µm	0.02 µm	0.15 µm
Environmental Protection (IEC529)	IP64	IP64	IP64	IP64
Length	90 mm	90 mm	64 mm	44 mm
Diameter	8h6	8h6	8h6	6h6

BAKER GAUGES INDIA PRIVATE LIMITED

An ISO 9001 : 2015 Company

Head Office-Pune

Tel. : (020) 66250600

Mob. : 7447449621

E-mail : bakerhip@bakergauges.com

Tel. : (020) 66093800

Mob. : 7447438251

E-mail : bakerbmi@bakergauges.com

www.bakergauges.com

Branch Offices :

Mumbai Tel. (022) 43471701 / 02 / 03

New Delhi Tel. (011) 23328186

Chennai Tel. (044) 28140963

Bangalore Tel. (080) 22217336

Ahmedabad Tel. (079) 27540665

Indore

Rajkot

Kolkata Tel. (033) 22156387

Chandigarh Tel. (0172) 4631027

Ludhiana

Hyderabad

Nashik

Jamshedpur

Coimbatore

• Mob. 7400199752

• Mob. 9810160313

• Mob. 7550055245

• Mob. 7618720651

• Mob. 7435041140

• Mob. 7447438257

• Mob. 7435041142

• Mob. 7447444980

• Mob. 9815601027

• Mob. 7447444098

• Mob. 7447443439

• Mob. 7447438256

• Mob. 7447444978

• Mob. 9884480963

• E-mail : bakermum@bakergauges.com

• E-mail : bakerdlh@bakergauges.com

• E-mail : bakerche@bakergauges.com

• E-mail : bakerblr@bakergauges.com

• E-mail : bakerbar@bakergauges.com

• E-mail : bakermp@bakergauges.com

• E-mail : bakerrajkot@bakergauges.com

• E-mail : bakercal@bakergauges.com

• E-mail : bakerchd@bakergauges.com

• E-mail : bakerldh@bakergauges.com

• E-mail : bakerhyd@bakergauges.com

• E-mail : baker_nsk@bakergauges.com

• E-mail : bakercal@bakergauges.com

• E-mail : bakerche@bakergauges.com



By Anvita Pillai

“LIMITED CHARGING STATIONS AND THEIR LOW VIABILITY IS A SIGNIFICANT BARRIER”

In conversation with **Nemin Vora, Chief Executive Officer, Odysse Electric Vehicles**, wherein he details what sets them apart from other EV players, the sustainability factor of EV and more. Excerpts...

With an electric revolution in place, what sets Odysse apart from prominent EV two-wheeler players such as Ather, Bajaj, etc.?

There are two things that we believe sets us apart in the market. First, compared to other brands we have given extra focus to the battery and charging stations, keeping the Indian climate in mind. We are continuously investing our time and efforts to provide a better and improved battery pack by using thermal sheets and gel which enables us to reduce heat generation and further ensures that the heat is routed out of the box. Second, the battery we use in each Odysse vehicle is passed through more than 50 checkpoints during its manufacturing process and is thoroughly tested by our technicians before installation & dispatch.

With the EV two-wheeler market getting further saturated with new and existing players, how do you plan on further entrenching and making a mark in the industry?

Any new industry is bound to encounter a phase where the market will get overcrowded but eventually, it gets consolidated too during its lifespan. We are constantly thriving to make our products safer and more





There have been efforts going on to invest in a new type of battery and also to reduce the use of expensive and rare minerals usage in existing lithium batteries to ensure even mining pollution is drastically reduced over time which is not possible with fossil fuels

advanced to ensure that we are exceeding the market offering and also developing new products where there is a void which can be filled by us, as a result, attracting new customers and retaining a base of loyal customers.

Although the market is growing with new players, customers are still reluctant to opt for an EV two-wheeler over a petrol-based bike. New policies have been bought in, and charging infrastructure is improving, so where do you think we are still falling short?

There have been a lot of efforts made in the EV segment though the recent safety issues have tightened the norms and brought a slight slump in the sale. Limited charging stations and their low viability are other significant barriers to the government's efforts to promote green transportation. There are only a few thousand chargers across India, some of which are in functioning order and others are vulnerable to the whims of local utilities over the power supply. This also is getting in the way of increasing EV sales, which recently struck a roadblock following a string of electric vehicles catching fire.

Although EVs are supposedly a sustainable alternative to ICE vehicles, on-road, EVs sustainability only plays out when it comes to emissions. The mining to manufacturing and charging processes for EVs is not sustainable, and not much headway has been made on the front. How can EVs be made more sustainable and circular?

For a mineral or even fossil fuels, there is always going to be mining carried out. But fossil fuel pollutes the air on top of other pollution. Alternatively, there have been efforts going on to invest in a new type of battery and also to reduce the use of expensive and rare minerals usage in existing lithium batteries to ensure even mining pollution is drastically reduced over time which is not possible with fossil fuels.

Your company offers both li-ion and lead acid-based scooters. What difference does it bring in the end product and the riding experience?

Lithium-ion and lead-acid batteries are the two most popular varieties. Different performances, life cycles and prices emerge from these chemical variations. For large-scale stationary applications with plenty of available space and minimal energy needs, lead-acid batteries work well. As a result, they are mostly utilised

in power plants and inverter-type systems for storing renewable energy. However, lithium-ion batteries offer the same power in a much smaller volume thanks to their significantly higher energy density. These batteries are environment friendly and do not cause severe health hazards. Lead, on the other hand, is a toxic substance that harms the environment and living beings in a comparable higher manner.

In addition, li-ion batteries do require less energy for maintained charging. Lead-acid batteries have a charge cycle efficiency of 80–85 per cent whereas lithium-ion batteries are 90 per cent efficient. Except for rapid charging technology, which drastically reduces the time, one lithium-ion battery pack charges to 100 per cent in around 2-3 hours whereas the Lead-acid takes time of about six to seven hours to fully charge

Lead acid usually has a 300-400 charging cycle capacity whereas lithium batteries can go up to 2500 charging cycles. On the other hand, the lead acid battery costs 50 per cent of that of lithium batteries but li-ion batteries are long-lasting and have a much lower cost of ownership over the life of the EV.

With experience gaining prominence in EVs, how are you working on creating a connected ecosystem for your two-wheelers?

We have recently developed our IoT system wherein customers will have an enriching user experience by making them aware of the money & CO2 saved by driving an EV compared to an ICE vehicle. IoT can also gauge the absolute & relative parameters such as speed, acceleration and braking pattern for providing tips to ensure better vehicle performance and reduce maintenance. Theft can also be prevented through real-time tracking, geo-fencing and immobilisation that enhance security and reduce the safety-related risk.

What are the short-term and long-term plans for Odysse?

We recently launched our product V2 & also developed our IoT. We have two other launches planned this year which would be a variation in electric bike and a cargo scooter catering to last-mile delivery service providers. We have 60+ dealerships across India and plan to cross 100+ dealerships by March 2023 and 200+ dealerships by 2024. Our R&D team is constantly working on upgradation of our existing models in addition to developing new products for the coming years. 

By Anvita Pillai

“IMTEX 2023 IS POISED TO BOOST TO THE INDUSTRY AT LARGE BESIDES ADVANCING BUSINESS”

Ravi Raghavan, President, IMTMA, in an interview with The Machinist talks about India's machine tool sector, the role of IMTMA in the sector's development and more. Excerpts...



How important is the role of the machine tools sector for India's development? Further, how can the machine tools sector enable India to become Aatmanirbhar?

Manufacturing and capital goods sectors are key to the economic growth and prosperity of any country. Any increase in the share of manufacturing in GDP can only happen when the machine tool industry is robust considering the sector has been the backbone of manufacturing in all developed nations. The Indian machine tool industry needs to have a strong foundation through continuous R&D, delivering new technologies, processes and products catering to the needs of various industrial segments. As this happens, the contribution of manufacturing to GDP, which is around 14-15 per cent currently can improve by several notches. The capital goods industry and machine tool industry grow faster by about 2 per cent points over GDP growth.

As mentioned above R&D, innovation and indigenisation are leading to localising imports and going further garnering export markets is the path adopted by the Indian machine tool industries.

Indian Machine Tool Manufacturers' Association (IMTMA), in its endeavour, to reach out to the emerging and champion sectors, offer

//

Indian Machine Tool Manufacturers' Association (IMTMA), in its endeavour, to reach out to the emerging and champion sectors, offer sector-specific solutions and have formed special interest task forces which focus on serving and building cross-sectoral business.



Largest Machine Tool and Manufacturing Technology Show in South and South-East Asia



International Machine Tool &
Manufacturing Technology Exhibition



International Exhibition of Cutting Tools, Tooling Systems,
Machine Tool Accessories, Metrology & CAD / CAM

Concurrent shows



International Exhibition on
Digital Manufacturing Technology

19 - 25 January 2023, Bengaluru, India

Key Highlights

- 5 Exhibition Halls
- International Seminar on Machining Technologies
- Aatmanirbhar Bharat Pavilion
- Special Focus on 3D Printing and Industry 4.0
- Academia Pavilion
- International Buyer and Seller Meet

For more information contact: Mr. Deepak Patil, Mob: +91 9892377080, Email: deepak@imtma.in

Organiser



Indian Machine Tool
Manufacturers' Association

Venue



Bangalore
International
Exhibition Centre



ufi
Approved
International
Event



Firmly backing the Union Government's push for a self-reliant India, the Indian machine tool industry is striving to build machines that have the right amount of performance and can be used as an alternative to imported ones.

sector-specific solutions and have formed special interest task forces which focus on serving and building cross-sectoral business. We believe that the initiative will help the industry to develop high-value and right-value machines for various varieties. Firmly backing the Union Government's push for a self-reliant India, the Indian machine tool industry is striving to build machines that have the right amount of performance and can be used as an alternative to imported ones. Efforts at indigenous technology development were on display in the Atmanirbhar Bharat pavilion at IMTEX 2022.

How can India help motivate MSMEs to become effective contributors to the Indian machine tools industry? What kind of steps can be taken by IMTMA and the government to help the MSMEs?

There are around 63 million MSMEs in India offering employment to about 110 million spanning multiple sectors.

IMTMA membership largely comprises MSMEs. Indian machine tool industry is largely driven and dependent on the supply chain represented by MSMEs. The share and contribution of MSMEs in machine tool building are vast.

We currently have nearly 153 active MSME members and are working with our members to form clusters for their growth and development. The Association, in 2020, formed 'COBIZ' to enable small groups of IMTMA SME members to discuss and work together for the mutual benefit of the western region. A total of 15 companies are part of this cluster. An IMTMA cluster, 'SAGHAYOG', for the northern region which comprises members from the national capital region of Delhi and Punjab was formed in 2021.

Further, we also conduct regional expos in Delhi-NCR, Pune and Chennai to bring manufacturing developments closer to the doorstep of various industry clusters situated in the northern, western, and southern regions. Our association has also formed task forces for finding out opportunities for machine tool manufacturers in emerging and champion sectors at the regional level. Our technology centres in Bengaluru, Pune and Gurugram impart skill development for young engineers, including the workforce from MSMEs. IMTMA also shares with its members government support schemes and motivates industries to be part of product and tech development besides

offering digitalisation courses to move ahead and align with global trends.

With the growing emphasis on the exports for the machine tools sector, do you see India becoming a major exporter any time soon? How is IMTMA planning to play a key role here?

IMTMA brings out country reports to find new opportunities in select geographical regions. It advocates for the creation of Indian technology centres in prospective countries and helps member companies develop products which are technology intensive to compete with the best in the respective categories to make them ready for exports. Parallely, we are encouraging industries to undertake technology development initiatives and have been encouraging technology transfer and merger/acquisitions besides encouraging foreign machine tool accessory manufacturers/supply chains to set up manufacturing facilities in India for building products in machine tools for the country and the world.

The working core group on exports constituted by IMTMA is also helping the membership in its endeavour to support, assist and guide our membership in exporting their products.

With the IMTEX 2023 coming next year, what are your expectations from it? How do you envision it will help the industry?

IMTEX & Tooltech 2023 is expected to be a comprehensive and highly focused show covering an exciting assemblage of new-age technologies that have assumed significance in the present manufacturing landscape as industries are gearing up to modernise their production capacities. With many features such as digital manufacturing, showcasing advancements in additive manufacturing and Industry 4.0, an international buyer-seller meet, a forum for direct connection between exhibitors and buyers from domestic and international markets, and i2 Academia Pavilion, a platform for academic institutions to showcase their R&D to industries, and so on, the exhibition is poised to give a much-needed boost to the industry at large besides advancing business to the next level. The kind of innovation which exists in the machine tool industry at every level – small, medium, or large, finds a place in IMTEX and hence, it is needless to say that the exhibition helps manufacturing growth on all levels. 

By Murali Manohar, Senior Director and General Manager, India Subcontinent, Infor

ON CLOUD: ACCELERATING INNOVATION & COLLABORATION IN AUTOMOTIVE INDUSTRY

With the growing demand for smart mobility, cloud connectivity possesses capabilities for supply chain transformation top-down. Read to know how.

With India being one of the largest passenger car manufacturing countries in the world, auto manufacturers are constantly innovating to keep pace with evolving trends. Today, customers are increasingly demanding smart mobility as well as uncompromised safety and quality in vehicles. This has resulted in leading OEMs incorporating advanced cutting-edge technologies to stay ahead of the innovation curve.

In the past few years, artificial intelligence and the Internet of Things have been revolutionising the automotive industry, which was once part of only luxury and high-end car models. However, intelligent automation is fostering innovation in the sector, leading to



Murali Manohar

connected cars and services becoming a reality in India. While the connected cars market is still in the developing stage in the country, it is anticipated to grow to \$32.5 billion by 2025, at a CAGR of 22.2 per cent between 2019-2025, according to the report by Research and Markets.

The drastic rise in changing business models and uncertainties has made supply chains increasingly complex. To manage disruptions and ensure supply chain continuity, automakers are realising the need to modernise their legacy systems to drive competitive differentiation. By leveraging flexible cloud technologies, production and logistics processes can be optimised to build a more robust and agile business. Harnessing modern collaborative tools and cloud connectivity has thus become essential





to drive efficiency across the supplier network and keep operations moving.

THE IMPORTANCE OF SUPPLY CHAIN

A functioning supply chain is the basis of efficient production. Suppliers provide the manufacturer with a wide variety of components - from simple parts to complex hardware and software. This makes it all the more important to build a well-thought-out supplier network based on a strategic sourcing plan. Close cooperation and real-time insights into the supply chain increase confidence in the logistics processes and even boost efficiency.

In this context, the return on investment (ROI) of suppliers is becoming increasingly important for the supply chain. However, it is no longer only traditional parameters such as costs that count; the strategic selection of reliable and well-known suppliers also contributes to customer loyalty.

REACTING IN REAL-TIME TO CURRENT DEMAND

Transparency via valid data streams and evaluation in real time helps both manufacturers and suppliers to react agilely to changing demand situations. This way, they can keep costs and margins under control and adapt to new trends in time. Manufacturers recognise interruptions in the value chain and can react earlier to disruptions caused by external influences. This is achieved, among other things, through the concept of a visual supply chain that can be displayed in the cloud at different locations, for example - in real-time. In this way, all those involved always have an insight into current events.

At this point, it is also advisable to use systems that enable seamless transparency across the entire supply

chain. They improve cooperation between manufacturers and suppliers and thus increase the efficiency of all work steps. Once full transparency is achieved within these processes, the supply chain can also be extended. For example, manufacturers can incorporate the needs of end consumers into their planning and develop new services or business models. And thanks to the connection with cloud technology, such an adaptation of the processes is possible for all parties involved in a timely manner.

GLOBAL QUALITY STANDARDS

THROUGHOUT SUPPLY CHAIN

Collaboration tools with cloud connectivity are an important foundation for these optimised processes. With the help of these tools, the complexity of supply chains can be managed while the quality of the end product increases. At the same time, quality managers can digitise processes, standardise audit types across the entire company and quickly identify potential problems. The tools continuously collect data, store it in the cloud and enable cross-functional access and evaluation for all stakeholders. Based on the collected data, all processes can be analysed and informed decisions can be made.

As a result, cooperation tools with state-of-the-art cloud technology support the development of trustworthy and global supply networks. In addition, they increase the market position of the manufacturer thanks to the agile action capability and scalability of the supply chain. In combination with assessment tools such as scorecards, common quality control standards (APQP, MMOG, audit control) can be easily implemented and quality management systems (QMS) implemented. This way, companies ensure that their suppliers always meet the highest standards and that all components of the logistics chain are optimally coordinated.

INDUSTRY TRANSFORMATION UNDERWAY

The transformation from an on-premises IT infrastructure to a cloud strategy modernises numerous processes in companies. It also improves supply chain agility. Cloud connectivity gives suppliers and trading partners worldwide access to central supply chain information. This allows companies to scale their production and logistics processes more easily and respond quicker to sudden changes in demand. This means they are well prepared for the increasing pace of innovation in the automotive industry. 

AUTOMOTIVE

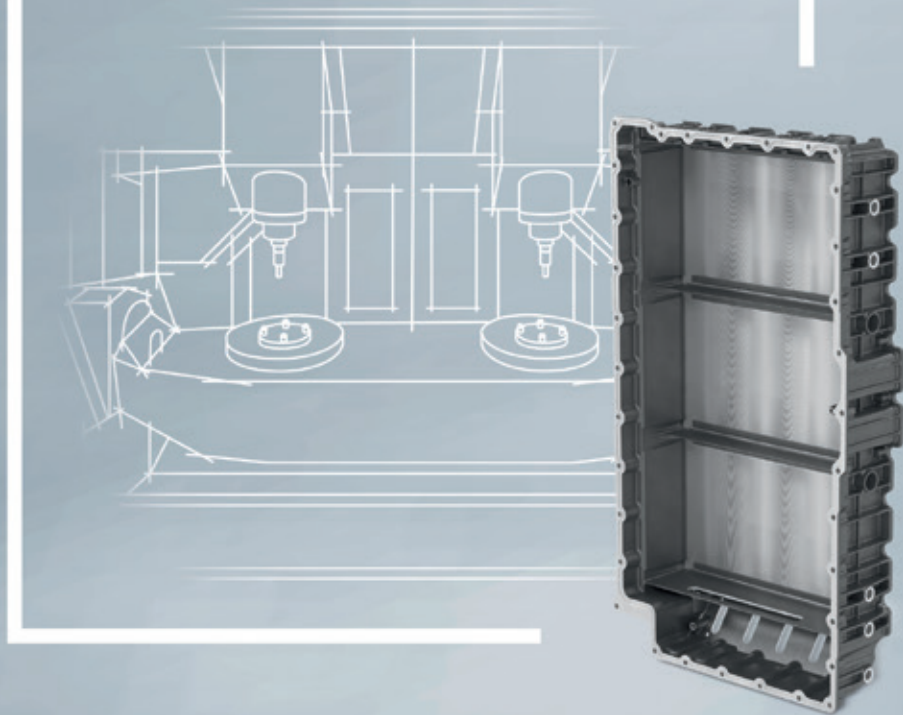

Two spindles for maximum productivity

600, 800, 1,200 mm: With their graduated spindle clearance, the three Series 22, 25 and 28 are precisely designed for the various workpiece dimensions and cover the whole range of sizes and complex components for automotive applications.



CHIRON Group

CHIRON India Machine Tools Pvt. Ltd.,
#33, Naseer Affinity, 1st Floor,
Miller Tank Bund Road, Kaveriappa Layout
Vasanth Nagar, Bangalore - 560 052 / India
P +91 80 4905 6490
info.india@chiron-group.com

www.chiron-group.com

By Karthik Raman, Head - Product Management, India, Kennametal India Ltd

CHOOSING HARD PART TURNING AS ALTERNATIVE TO GRINDING

As the process of machining turns more and more complex, looking for an alternative, i.e., grinding, as a viable option broadens the horizon of the workpiece involved and benefits reaped. Read to know how.

As machining complexities continue to evolve with customers looking at new ways to balance precision with productivity, the advent of hard part turning has emerged as an ideal alternative to grinding.

Broadly, hard part turning refers to the machining of parts with a hardness of above 45 HRC, although most frequently the process concerns hardness of 58 to 68 HRC. The workpiece materials involved include various hardened alloy steel, tool steel, case-hardened steel, high-temperature alloys, nitride irons, hard chrome coated steels, and heat-treated powder metallurgical parts with application across end markets such as transportation, general engineering, energy, and aerospace.

There are several clear benefits of turning with a



Karthik Raman

PCBN insert over the conventional grinding process for finishing hardened steel parts. Turning centres are less expensive and offer process flexibility as compared to grinding, without compromising on high precision needs, thus saving both time and cost. With new wiper geometries on the polycrystalline cubic boron nitride (PCBN) inserts, it has become convenient and easy to leverage turning

for even demanding surface finish requirements.

Gear wheel bearing surfaces are a typical example of early applications converted from grinding to hard machining using inserts in PCBN. Some additional advantages over grinding include being easy to adapt to complex part contours, quick changeovers between component types, consolidation of operations in one set-up, high metal removal rate, low machine tool investment, elimination of coolant in most cases, small tool inventory and eco-friendly metal chips.

CHALLENGES IN HARD PART TURNING

It is mainly a finishing or semi-finishing process where high dimensional, form, and surface finish accuracy must be achieved. Since material hardness is > 45



Turning centres are less expensive and offer process flexibility as compared to grinding, without compromising on high precision needs, thus saving both time and cost.

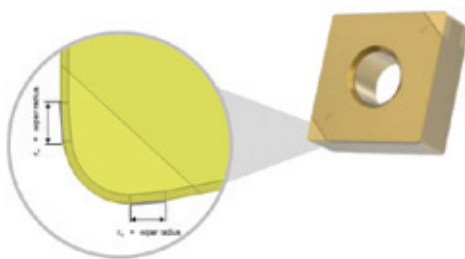



Engines For A Lifetime

Indian at heart
and in every part

INNOVATING EXCELLENCE SINCE 1922

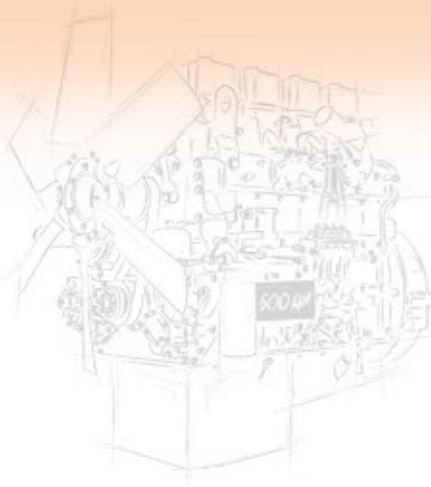

Founded in 1922 with the development of the first diesel engine in India by Sir Dhanjisha Bomanji Cooper, the Cooper family has been an industry leader for 100 years. Under the leadership of Mr. Farrokh Cooper, the founder's vision of innovation continues to pave the way for the growth of the organization. With Cooper Corporation becoming a trusted partner for global giants in automotive, marine, and agriculture sectors. With a drive to continuously update, and upskill, we hope to continue raising the bar for efficiency and innovation.

COOPER
GENSETS
सबसे ऊपर COOPER



Auto
Components



5-250 kVA
Diesel Gensets



2, 3, 4 & 6 Cylinder Engines



Product Range: Engine, Engine Components, Genset, Marine Engines, Engines for Fire Pump
Toll Free No. - 1800 12000 4001 | Website - www.coopercorp.in



ID and Face Finishing of Gear Wheel

Ref: TPR #21-252739

Challenges/Criteria:
ID & face finishing Ø125 (4.9")
Smooth cut
Length 40 mm (1.6")
Tool life improvement

Remedy/Result
With new GW double sided KBH10B Wiper we had been able to outperform competition.
Double tool life.

Work piece: Gear wheel
Material: 5120 (56-60 HRC)

Properties:
Machine: EMAG V5C315
Tool:
Insert: CNGA120412501515GWDMT KBH10B (CNGA43350615GWDMT KBH10B)
Competitor: CNGA120412GSW4 PCBN



	Competitor	Kennametal
V_c [m/min] (sfm)	100 (328)	130 (426)
f [mm] (inch)	0.35 (0.014)	0.25 (0.01)
a_p [mm] (inch)	0.15 (0.006)	same
R_a [µm]	none	none
Tool life	250 pcs. / 112 minutes	500 pcs. / 241 min.

© 2021 Kennametal Inc. All rights reserved. Proprietary and Confidential

HRC, it can induce high tool tip temperature which if left unmanaged can result in high stress on the component or the formation of white layers. Process parameters have a narrower range of acceptable values than in conventional turning, and failure to properly optimise may lead to a combination of poor tool life, poor surface finish and unacceptable dimensional accuracy on the component.

CUTTING TOOL CHARACTERISTICS

In hard part turning, the selected cutting tool should have a high indentation hardness, high hardness to modulus ratio, high thermal conductivity, high abrasive wear resistance and high thermal, physical and chemical stability. The cutting tool should be wear-resistant, tough, and chemically stable. Among all the available cutting tool materials, PCBN scores high on these parameters and thus is an optimum choice for such applications.

HOW TO OVERCOME CHALLENGES WITH RECENT INNOVATIONS?

In hard part turning applications, generally, the requirement of surface finish and geometrical accuracies on the part are very stringent.

In applications, where we do not need a superior finish – with Wiper technology we can double the feed rates and improve the overall efficiency. The -GW wiper geometry besides offering good process stability, also generates the lowest cutting forces, thanks to the new developed curved edge Wiper design technology.

The double-sided PCBN mini tip offers the best economy with a higher number of cutting edges. The



Process parameters have a narrower range of acceptable values than in conventional turning, and failure to properly optimise may lead to a combination of poor tool life, poor surface finish and unacceptable dimensional accuracy on the component.

new coating enhances the speed capabilities and provides longer tool life. The outer TIN layer helps to detect the wear more efficiently. Overall enhanced edge preparation for longer tool life, reliable performance, better surface finish and machining accuracy.

KBH10B & KBH20B is the improvement of our H05 to H20 PCBN hard part turning portfolio and the latest addition to KBH10 & KBH20. The target markets are automotive transmission, drives and brake systems.

One such proven case is given below.

Kennametal tools offer the following features and benefits that make them an ideal solution for hard turning:

- PCBN tipped insert
- Designed for hard-turning applications
- KB5630 can also be applied for roughing to finishing in interrupted cuts on hardened steels (>45 HRC) and grey cast iron, chilled irons, high chrome alloyed steels, high temp alloys and sintered powder metals.

smart plastics



Avoid unplanned downtime

Scan the below QR
to visit our Virtual
Exhibition Booth



Industry 4.0: smart plastics eliminate downtimes

Intelligent products give a maintenance alert ahead of time and can be integrated into standard predictive maintenance; smart plastics allow your equipment to run continuously as well as reducing maintenance costs.

igus® (India) Pvt. Ltd.
36/1, Sy. No. 17/3, Euro School Road, Dodda Nekkundi Industrial
Area - 2nd Stage Mahadevapura Post Bangalore - 560048
Phone +91-80-69116900 Fax +91-80-68127802 e-mail info-in@igus.net

igus®.in

By Philip HF Wallner, Manager – Industrial Automation & Machinery, MathWorks
R Vijayalayan, Senior Manager, Application Engineering – Automotive Industry, MathWorks

VIRTUAL COMMISSIONING – ENTRY TO MODEL-BASED DESIGN & SPRINGBOARD TO SMART INDUSTRY

The current part two of the article carries forward the explanation of why model-based engineering is a step closer to efficient engineering

To prepare for the implementation, the models are provided with the data types that will later be used on the PLC. This can also be done largely automatically with tools such as fixed-point designer. After refinement and optimisation to the required accuracy, code can then be generated. However, this is not necessarily written immediately to a controller, but for example in a Dynamic Linked Library (DLL).

This can then be run on a PC or other computer hardware and tested in interaction with the plant model or physical plant. In this way, the functionality of the machine and software can be extensively tested and verified step by step before any hardware is even ready.

Errors are thus found and eliminated early in the development process, and subsequent integration is faster and smoother. In addition, scenarios can be tested that would not be possible on the real machine for safety reasons or because of the risk of damage. Various

//

If machine and plant builders follow the paradigm of model-based development, virtual commissioning no longer takes place at a specific point but, like testing and verification, continuously with each intermediate step.

suppliers, such as Siemens, Beckhoff or Rexroth, also enable the simulation of the complete PLC on computer hardware as an intermediate step.

FROM DEVELOPMENT SEAMLESSLY TO OPERATION

If machine and plant builders follow the paradigm of model-based development, virtual commissioning no

A Different View of the Lifecycle

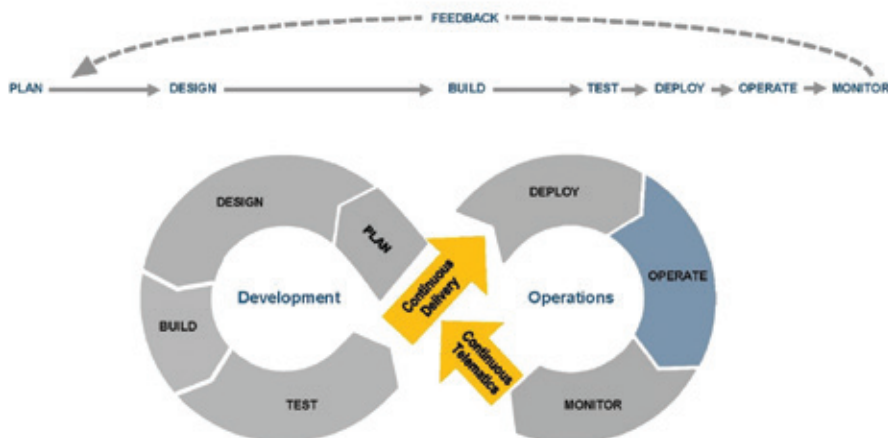

The lifecycle of a mechatronic product from a DevOps perspective. © 1984 - 2022 The MathWorks, Inc.



Entry into the smart industry demands a fundamental change from machine and plant manufacturers. A useful starting point for this is virtual commissioning.

longer takes place at a specific point but, like testing and verification, continuously with each intermediate step. They can therefore approach the physical machine with confidence that it will function as desired.

However, the benefits of the models built up along the way are by no means exhausted. They play a central role in the intended smart industry in the further life cycle of machines and plants. They can serve as digital twins of plants in operation and allow both operators and manufacturers to continuously monitor the actual condition of plants.

Applications for this include predictive maintenance, identifying opportunities for energy savings, comparing behaviour under different environmental conditions by collecting fleet data, and also ideas for further technical improvements by the manufacturer.

3D simulations of complete plants and production lines make an important contribution to this. Operating faults or conspicuous data can be better understood and classified in the overall context. This can be done, for example, by highlighting or marking locations where problems have already been identified. The added value of a game engine-based overview model thus continues during the operating phase.

CONTINUOUSLY UPDATABLE MACHINES: DEVOPS IN MECHATRONIC SYSTEMS

Making machines more flexible and constantly equipping them with new functions poses two challenges. Operators want to manage this as uninterrupted as possible. For manufacturers, on the other hand, such a development effort can only be managed if their engineering teams can concentrate on the essentials.

The basis for this is once again the finished machine models in the form of digital twins. Their modularity significantly reduces the integration effort and certain tests and checks only have to be performed for the modified parts. In addition, since many processes can be automated script-based in the simulation, existing test suites can be supplemented and then run through largely without human intervention. The overall effort is thus considerably limited.

In this way, a new digital twin is first created before the changes are transferred to the physical plant - in the best case online in the case of pure software. The physical plant then sends new data back to its digital twin for comparison. Machine and digital twin thus keep each other constantly up to date.

Intended hardware changes are also first simulated

and tested as described above. Only when these tests have been fully passed are physical parts produced. The extensive automation of the test sequences described their scalability on multi-core and multi-processor systems, for example, as well as the automatic code generation, gives the engineers the necessary scope to spend their time on actual development work. Detailed changes to hardware or drive design are therefore possible at any time without investing in parts and waiting for them to be manufactured.

This creates a cycle of development, transmission to the machine, whether in the form of hardware or software, operation, and data flow back to the manufacturer, who in turn further develops the machine based on this.

In the software industry, this is the proven DevOps cycle depicted as a lying eight. It stands for continuous development processes in which operators and manufacturers benefit from mutual exchange and changes or bug fixes take place faster and with minimal interruptions.

This is made possible by the consistent use of models in every phase of a product's life cycle. Everyone involved, whether developer, designer, sales employee or operator, understands these models at the level required for them and with the tools and visualisations connected for them. This not only creates a common basis, but the models also form a language in which people communicate with each other. This universality creates the basis for a successful digital transformation.

A STEP CLOSER TO BETTER ENGINEERING

Entry into the smart industry demands a fundamental change from machine and plant manufacturers. The basis for this change will be model-based development, as has already happened in many other industries. A useful starting point for this is virtual commissioning. It forms the interface between software developers and designers on the one hand, and the manufacturer and the operator on the other.

The models developed for this purpose are pointing the way step by step to an ever-broader use of simulation and modelling and thus to more efficient development processes and more innovation. Approaches such as game engine-based 3D simulation allow insights into the overall behaviour of plants. In this way, they help to better understand the overall behaviour of plants and make digital twins an even more effective means of commissioning, maintaining and further developing plants. The idea of continuously updatable machines, which are also capable of offering small batches through to individual items with the efficiency of mass production, is thus moving a step closer. 



By Anvita Pillai

THE LEADING LADY OF ELECTRIC!

From humble beginnings in Odisha to becoming the CEO of Mahindra Electric Mobility, **Suman Mishra's** journey is nothing short of a tale of zealotry. In an exclusive conversation with **The Machinist**, she talks about her journey, role in women empowerment, MEML business, future plans and more. Excerpts...

Starting from the famous land of temples, Odisha, to becoming the Chief Executive Officer of the world's pioneer electric vehicle manufacturer, Mahindra Electric Mobility (MEML), Suman Mishra is an out-of-the-norm leader in the Indian automotive industry. She has managed to make a mark through her decisions and skills in an industry that is rather a paradigm of male dominance.

An academically inclined Mishra was in the top 5 per cent of the class with first-class honours in BSc in Computer Engineering from Nanyang Technological University Singapore and rounded off her education with an MBA from the US Ivy League, Michigan Ross.

"We focused on delivering customer-centric solutions through our electric vehicles which provides a better total cost of ownership and a superior driving experience."

MAKING THE OBVIOUS CHOICE

Her professional journey has been of equal verve spanning several industries and functions. "I have so far worked in Singapore, USA and India and in functions including sales, finance, pricing, manufacturing, procurement, organisation structure amongst others across the retail industry, financial services, automotive and assembly, chemical industry and technology. This has helped me appreciate both the common challenges, approaches and best practices across industries," cites Mishra. However, to her, working in the manufacturing sector was a natural choice. She remarks, "I have always

had a proclivity towards manufacturing industry from my specialisation with Tauber Institute of Global Operations, MI; McKinsey & Company's industrial operations practice where I worked with auto and industrial majors."

Since her take over as the Senior Vice President at Mahindra Group in 2015, she has worked in a variety of roles including strategy, automotive business transformation, group capital allocation, etc. So, she reveals, "The shift to Mahindra EVs was a natural transition."

THE PANDEMIC & LEADERSHIP

Mishra stepped into the role of CEO at MEML in mid-2021. As the CEO, her regular KRA would include driving performance transformation across sales, marketing, product planning, development, scaling up expertise, etc. However, when she took up the role in 2021, it was far from what was stipulated or expected from her. Taking over amidst a raging pandemic wasn't easy; the company's main business line – the electric three-wheelers – had registered a strong slump. "The three-wheeler industry registered sharp degrowth after the pandemic and is yet to recover to pre-pandemic levels. The pandemic significantly affected the earnings of our customers, particularly in the passenger segment," she mentions.

Further, trying to create and scale a new category in the context of these market conditions was the biggest challenge the company faced. But Mishra suggests, that what helped them recuperate was focusing on customers. "We focused on delivering customer-centric solutions through our electric vehicles which provide a better total cost of ownership and a superior driving experience."

As a leader navigating through, perhaps, the



“We make every effort to actively hire women and provide them with opportunities to fulfil their potential. Mahindra believes in gender equality, and as long as the candidate is fit to carry out the role, they are hired based on merit.”

toughest of times, Mishra gave out the golden rules which she swore by:

- **Staying Grounded:** As a leader, it is important to stay grounded to the purpose which works as a north star for decision making
- **Having A Clear Vision:** The role of a leader is to establish a clear vision with clear priorities while decluttering distractions along the way
- **Aligning On Common Goals:** A leader must build a team which is aligned behind a common purpose and willing to strive to reach overall company goals

Needless to say, it has been working wonders for the company. Mahindra Electric closed its current financial year with a market share of 73.4 per cent, making it amongst the top electric three-wheeler manufacturer in the country, experiencing a whopping 214 per cent growth from financial 2021.

WOMAN LEADING WOMEN

Breaking gender stereotypes has been an ingrained facet of Mishra's upbringing, which she translates into her leadership style. Being a “woman” leader only meant a chance for her and the company to motivate and ingrain the mindset of ‘merit over gender’. She alludes, “We make every effort to actively hire women and provide them with opportunities to fulfil their potential. Mahindra believes in gender equality, and as long as the candidate is fit to carry out the role, they are hired based on merit.”

Currently, Mahindra's EV division employs more than 100 women in various pivotal roles in its Chakan and Bengaluru offices. The female employees are part of the assembly and testing teams at the manufacturing plants, as well as are involved in operating, supervisory and executive roles.

BUSINESS PLANS & CREATING OPPORTUNITIES

While India's EV market is proliferating, it is still

at a very nascent stage, and Mahindra Electric's objective is to support the increase in the penetration of electrification. With India's EV segment turning highly competitive, Mahindra Electric plans to lead the segment by capturing a rather promising market – last-mile mobility.

The increased penetration of e-commerce has been a silver lining for the company, too, in the last two years considering the business boost it has presented to its cargo segment. “In the cargo segment, growth has been somewhat better driven by increased penetration of e-commerce,” Mishra mentions.

A recent report by World Business Council for Sustainable Development (WBCSD) titled, ‘Advancing electrification of e-commerce deliveries in India’, India's e-commerce sector, which will contribute to nearly 3.5 per cent of the country's GDP, will witness a 100 per cent adoption of EVs. This would ultimately curb 44 per cent of the CO2 emissions by the sector's conventional vehicle counterparts and reduce consumption of 30 billion litres of fossil fuel per year.

According to Mishra, the company plans on monetising the opportunity presented by the e-commerce sector to its best capacity. She emphasises, “I believe we will continue to innovate and evolve in this journey to self-sufficiency and set up our own India model to lead the world in electrification led by last mile mobility.”

With the innovation spree in the EV sector, wherein manufacturers are working on building in-house batteries to match the demands and requirements of India, Mahindra Electric has no plans on slacking to build in-house batteries. Mishra mentions, “Mahindra Electric Mobility continues to focus on its in-house battery pack manufacturing as well as BMS development. We are also exploring partnerships with tech-driven companies as well as start-ups for alternate chemistry batteries, and recycling.”

India's EV ecosystem is evolving, however, working

independently is no longer going to help, creating synergies would; Mishra envisions a combined effort to be in play. “Globally, the automobile industry is at the cusp of a major transformation. Growing concerns about energy security and environmental pollution clubbed with rapid advancement in technologies for powertrain electrification, innovative models and ever-increasing customer expectations are transforming automotive businesses,” she implies.

PUSH STARTING THE LONG JOURNEY

Being at par with the world in EVs is still a long road ahead and shifting from the dependency created by ICE vehicles will be a difficult journey to make. However, Mishra believes with policies on the demand and supply side, such as FAME-II, PLI, GST, road tax waiver and state-level incentives, the GOI has enabled this transition and created a strong jumping-off point for the industry. She adds, “The Phased Manufacturing Program (PMP) in FAME-II and now the PLI Schemes for ACC, auto & auto components are aimed at the development of domestic manufacturing ecosystem of EVs and its components, including battery cells, thereby increasing the domestic value addition and creating capacity building and employment opportunities. These initiatives and policy level interventions are expected to reduce import and bring in lower costs, thereby, making the EVs more affordable.” She further emphasises that the rationalisation of Basic Customs Duty (BCD) on critical components used in EV manufacturing has also helped OEMs to encourage indigenous manufacturing of such components.

Price is a major tipping factor for the Indian audience. Given that EVs are priced on a higher end compared to one’s average ICE engine vehicle, opting for them has not been on high priority for customers.

However, Mishra believes, the bold policy reforms will see India succeed in making EV technology more affordable and accessible for everyone, but it will be essential to continue the policy for long-term growth. She emphasises, “Specifically, the demand incentives for EV buyers should be continued till the time price parity between EVs and ICE vehicles is attained. Similarly, the FAME-II Scheme and the state EV policies need to be extended to envisage benefits for customers for a further period to compensate for the time lost due to Covid-19 and to ensure that momentum is maintained.”

Mishra also points out that While EVs are priced at a premium to their ICE counterparts, they deliver a significant total cost of ownership (TCO) advantage. She explains, “For example, based on average usage of a CNG three-wheeler over five years of its lifetime, an EV helps the customer to save in the range of Rs 2 lakh considering all the operating, financial, maintenance expenses. The TCO will continue to improve as we see cell cost reduction, semi-conductor availability and achieve economies of scale.”

She emphasises, “Once customers realise the benefits of EVs, both financial and environmental, the pace of adoption will go up significantly.”

IS EV TRULY SUSTAINABLE?

The “sustainability” factor of EVs has been questioned for quite a while now. Several studies suggest that electric vehicles are no less damaging to the environment than one’s average diesel engine vehicle in terms of carbon footprint. The green vehicles are only truly green from an emissions perspective and lack to be thereof sustainable or green right from manufacturing to charging, yet. However, Mishra opines that EVs create a lower carbon footprint throughout their lifetime than the traditional ICEs even after accounting for the production emissions.

There is a lot of scope for further reducing the carbon footprint across the value chain, such as production, transportation, charging, recycling etc. “Dialogues and partnerships have to be initiated where companies can work on pilot projects starting from manufacturing to recycling with the right support from the government,” she suggests.

Additionally, the push by the government is also technologically agnostic not limiting to certain battery chemistry. Industry and ecosystems globally and nationally





Specifically, the demand incentives for EV buyers should be continued till the time price parity between EVs and ICE vehicles is attained. Similarly, the FAME-II Scheme and the state EV policies need to be extended to envisage benefits for customers for a further period to compensate for the time lost due to Covid-19 and to ensure that momentum is maintained.

have already started working on alternate chemistries, fuel cell technologies, etc. She emphasises, “Increased investments in renewable energy solutions and advanced recycling plants will reduce over-reliance on rare earth metals such as lithium.”

THE ELECTRIC FUTURE

The year 2022 so far has been full of milestones for Mahindra Electric Mobility. Mahindra’s last mile products have cumulatively travelled more than 427 million kilometres and saved more than 42835 metric tonnes of CO₂, so far. Its electric three-wheelers alone have covered more than 115.12 crore kilometres and Mishra believes this is a testament to the company’s technological prowess as well as reliability. The company’s Treo auto is currently amongst the top-selling electric three-wheeler in the passenger category with a market share of 70.4 per cent while the Treo Zor is leading the cargo segment with a 52.1 per cent

market share.

More and more customers prefer opting for Mahindra Electric’s vehicles because of the significant savings due to the ever-increasing petrol/diesel/CNG prices, advanced li-ion technology, and favourable government policies. The high reliability of the EVs, extensive service network and aggressive marketing, as well as sales policies, also contributed to this success.

Talking about what lies ahead for them, she says, “We have a range of new as well as exciting products lined up for this financial year. We have launched the all-new Zor Grand electric cargo three-wheeler in this quarter.”

“We will continue to bring in customer-centric products to the market and keep delighting the customers by giving them a true EV experience. The 800+ service touchpoints, easy finance options and superlative reliability of our offerings will help improve the ecosystem for our customers,” signs off Mishra. 



By Shreyas Shibulal, Founder & Director, Micelio Mobility

SCALING INDIA'S BATTERY ECOSYSTEM: CRUCIAL NEXT STEPS

With an EV revolution in pipeline, it is important to establish an infrastructure to support the developing ecosystem – a important part of which is batteries. The article elaborates on why a strong in-house battery building infrastructure is key to a successful EV business in India.

At this point, the writing on the wall is quite clear - electric vehicles (EVs) are the future of mobility. With many governments committing to transition to EVs and providing strong policy support, they are now increasingly being seen as a viable alternative to conventional vehicles with internal combustion engines (ICEs). EVs are a ripe opportunity for disruption, for example, just look at Tesla, and India has the opportunity to redefine itself as a global leader in clean mobility. However, to make this a reality the nascent EV industry in India will need to be supported by a robust battery ecosystem. Batteries are one of the most critical aspects of an EV, comprising significant portion of costs and a direct bearing on the number one consumer concern for EVs - range. Boosting the domestic battery ecosystem will be essential to the growth of the Indian EV industry as well as the viability of other green technologies like renewable energy.

The EV market in India is young but is also growing at an exponential rate. It is projected to grow at a

//

Batteries are one of the most critical aspects of an EV, comprising significant portion of costs and a direct bearing on the number one consumer concern for EVs - range. Boosting the domestic battery ecosystem will be essential to the growth of the Indian EV industry as well as the viability of other green technologies like renewable energy.

compounded annual growth rate of 90 per cent and touch \$150 billion by 2030. The projected total sale of EVs (two-wheelers, three-wheelers, cars, buses) in 2022 was 10 lakh units - this is the amount of EVs sold cumulatively over the last 15 years. To meet this





demand for EVs, the automotive industry will need an annual battery capacity of 158 GWh by FY30. For context, 198 GWh was the global output of lithium-ion (li-on) battery cells in 2017. So, the scale of the task is monumental.

THE BATTERY CONUNDRUM

These forecasts present multiple major concerns as the availability of li-on batteries are extremely limited in multiple ways. Firstly, the availability of the rare earth elements critical to produce li-on batteries like lithium, nickel and cobalt is limited to a few geographical areas. For example, Russia and the Democratic Republic of Congo have a majority of the world's nickel and cobalt supplies respectively. Furthermore, many of the mines as well as the refinement factories for these rare earth elements are owned or operated by China. Given that the majority of Indian EVs use imported batteries or batteries assembled with imported parts, this presents a major challenge. These issues are only compounded by the fact that there may simply not be enough of these materials on Earth – remember that li-on cells are used for not just EVs but smartphones, tablets, laptops, cameras and most electronic devices.

Even if the problem of scarcity of raw materials can somehow be sidestepped, there are other challenges that need to be overcome. For example, the reliance on imported batteries for EVs, means that they are not designed for Indian conditions. Indian EV manufacturers look to source from major OEMs due to their economies of scale. But as these OEMs are geared towards European markets, they produce batteries whose ideal operating conditions can be as low as 25-degrees Celsius, making them quite ill-suited to Indian conditions.

Furthermore, there is no standardisation of battery technologies that go into EVs. While this is an overall issue with EVs, it becomes particularly important for



There is no standardisation of battery technologies that go into EVs. While this is an overall issue with EVs, it becomes particularly important for batteries when they need to be recharged.

batteries when they need to be recharged. This is a popular concern with the public as consumers have anxiety about the actual distance, they can cover using their EVs. The optimal solution would be to have a network of stations where consumers can take their EVs to have their batteries recharged or swapped, much like ICEs have fuel pumps. However, much like fuel pumps this network of stations would need to operate across all vehicles to provide maximum utility. Given that each manufacturer has their own charging standards, ports and designs it creates a fragmented system that is sub-optimal.

STEPS TO BUILDING A ROBUST BATTERY ECOSYSTEM

So, what can be done? The first priority should be prioritising local manufacturing, which will require significant research into battery designs. The first area of research will be maximising the efficiency and longevity of li-on batteries, which will still remain dominant. This includes both R&D on battery management systems to maintain optimal battery health as well as on new types of anodes, cathodes and electrolytes. Solid state batteries that replace the liquid or polymer gel electrolytes of existing li-on batteries with a solid electrolyte are one such promising technology. Conducting

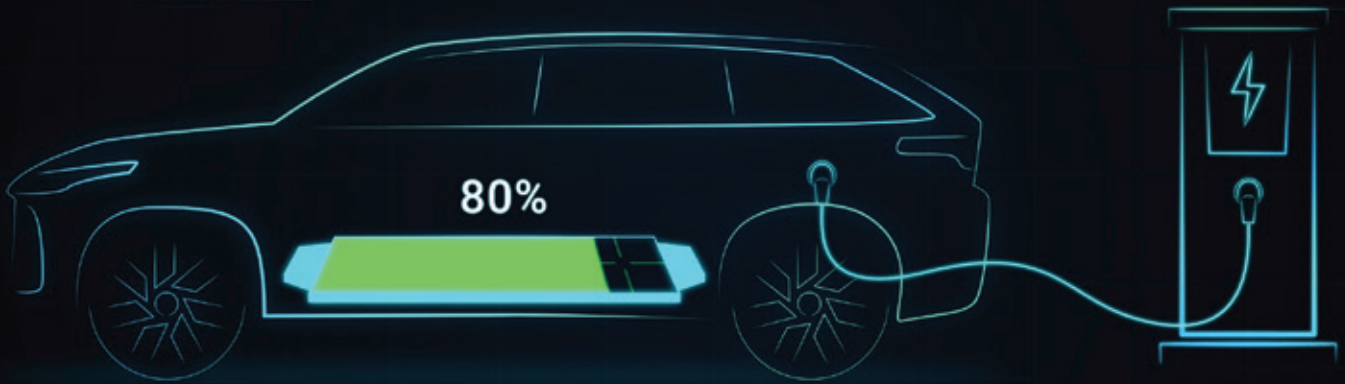

//

EVs will become the norm in the next few decades and 2022 may be remembered as the year that the EV industry in India truly started gaining momentum. The growth of the industry will be predicated on the extent to which a robust battery ecosystem can be established. Aatmanirbhar Bharat is very much a possibility for the Indian EV industry.

this R&D in India will help ensure that these batteries are designed for use in Indian conditions.

Additionally, research should go into alternative battery chemistries to replace li-on batteries that use zinc and sodium instead of lithium. The government's Production Linked Incentive for advanced battery chemistries that committed Rs 18,100 crore was a good first step in this regard. While not all of these battery technologies will be suitable for EVs, they can be used in other technologies and free up li-on batteries for use in EVs. For example, they may be suited to solve the problem of intermittent generation in renewable sources of electricity by providing effective energy storage.

Priority should also be given to technologies that use raw materials, like zinc and manganese, that India has an abundant raw supply of already. Given global

issues with the supply of rare earth elements like lithium and cobalt, the government can also help support the EV industry by creating a dedicated department to source supplies for indigenous production of batteries.

The government has already played such a critical role in supporting the EV industry with measures like FAME II, PLIs, and DLIs. The next logical step is issuing standards and prescriptions for EVs in the same way that they do for other classes of vehicles. This will undoubtedly be extremely difficult to achieve politically as well as commercially as the organisation that owns the IP for a battery design will unsurprisingly want to retain its competitive advantage. Compulsory licensing is one possible tool to achieve this, but it is too blunt and forceful, and may end up with net negative effects. Voluntary licensing mechanisms like FRAND (Fair, Reasonable and Non-Discriminatory) licensing are an alternative pathway to setting standards to provide clarity to both consumers and manufacturers.

POWERING THE FUTURE

EVs will become the norm in the next few decades and 2022 may be remembered as the year that the EV industry in India truly started gaining momentum. The growth of the industry will be predicated on the extent to which a robust battery ecosystem can be established. Aatmanirbhar Bharat is very much a possibility for the Indian EV industry. There is an opportunity for India to become a global leader, especially for the two-wheeler category but making Aatmanirbhar EVs a reality will first require Aatmanirbhar batteries. 

By Dr Christoph Jaschinski, Senior Vice President – Global Business Development, Leadec India
Sudhir Gurtoo, Managing Director, Leadec India

MELTING ICE FOR EV MOMENTUM

Close to a third of all vehicles sold in India are expected to be electric by 2030. By that time, nearly one in every 10 electric vehicles sold worldwide will be in India.

Despite this positive prognosis, India's EV space is at a nascent stage. There are several reasons why we need to overcome these obstacles for the EV market to gain momentum. The article light on how specialised service providers can support this journey.

The ice is melting – this is true for the ice of the polar caps as well as for ICE as in Internal Combustion Engines. ICE vehicles will continue to melt away, and EVs will continue to grow, but it will take some more time than many believe. Although experts are very positive about the development of the Indian EV market, we are lagging behind in many areas.

COST IS KING

The Indian customers are heavily cost-conscious – and EVs still are more expensive than comparable ICE cars. But the demand for EVs is also growing in India. With the continuous increase in fuel prices, electric vehicles are becoming more attractive to Indian people.

The Indian NEV sales leaderboard underlines the growth of this market. It is very dynamic and fast-paced, dominated by affordably priced brands and an increasing number of innovative Indian start-ups.

The costs of a battery system account for the largest share of the manufacturing costs of a vehicle, up to



Dr Christoph Jaschinski



Sudhir Gurtoo

30-40 per cent of total manufacturing costs. This is a challenge for acceptance in India where, in addition to innovation, the price of the vehicle is the most important purchase criterion. Therefore, all current forecasts show a faster spread of EVs in the two-wheeler segment than in the passenger car segment.

While e-rickshaws are doing very well in the north of the country, e-two-wheeler sales are creeping up to 4 per cent of all two-wheeler sales this year. A total of around 30 manufacturers are competing in this market. On a YoY basis, electric two-wheeler sales increased 370

per cent in March 2022 with Hero Electric in the lead, followed by Ola Electric and Okinawa. These companies and others are offering new models with better battery life, while Tata is leading the e-car market.

However, with the new process technologies, the manufacturing costs per KWh will decrease during the next few years due to further development of new materials and their application technologies, irrespective of the location of the plant.

The processes in battery cell production are not yet as indus-

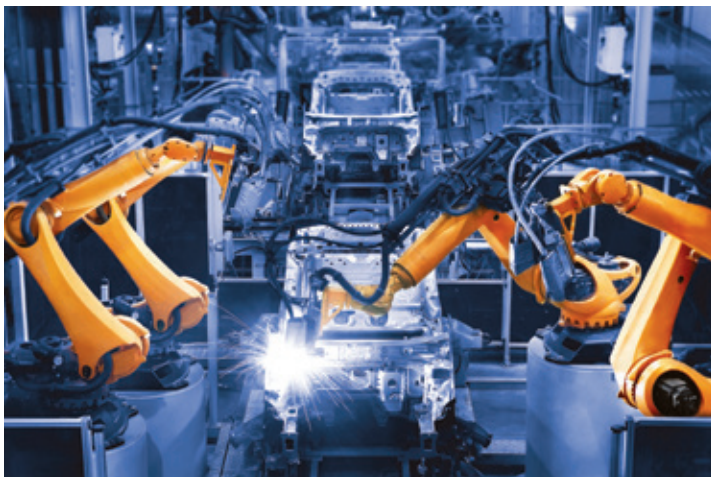

6TH EDITION

THE ECONOMIC TIMES
**Global
Conference on
Plastics in
Automotive**



Powered By



In Association With



**SUSTAINABLE PLASTICS FOR INNOVATION
IN THE AUTOMOTIVE INDUSTRY**

COMING SOON

OUR LAST YEAR PARTNERS

Lubricant Partner



Platinum Partners



Gold Partners



Silver Partner



Supporting Partner



Magazine Partners



For Sponsorship, contact

Ranjan Haldar | M: 9167267474 | ranjan.haldar@wmm.co.in

For Registration, contact

Shruti Nair | M: 9769621841 | shruti.nair@wmm.co.in

For Editorial and Panel Discussion Participation, contact

Anvita Pillai | M: 98201373510 | anvita.pillai@wmm.co.in



trialised as the assembly processes for ICEs. With new R&D centres in India and Southeast Asia, the manufacturing costs for cells will decrease faster and suit the price sensitivity of Indian customers.

Another possibility to reduce costs is to fully localise vehicle parts and assembly. Today, good imported electric cars are subject to high taxes. Currently, India levies an import duty of 100 per cent on cars whose Cost, Insurance and Freight (CIF) value exceeds \$40,000 (Rs 30.6 lakhs), according to the Society of Indian Automotive Manufacturers (SIAM). Apart from this, India imposes a social welfare surcharge of 10 per cent on electric cars. As soon as the production will be localised these barriers will become less relevant. We know that top seller Tesla is also interested in manufacturing cars in India.

Ramping up production facilities for EVs and even more for cell production will, therefore, be a crucial factor in the transformation of the automotive industry in India. Major Indian automakers, such as Tata Motors, Mahindra & Mahindra, Hyundai Motor and Maruti, have announced significant investments and are trying to make a leap. International manufacturers, like Stellantis, Toyota, Audi, BMW and others, are also mulling new facilities for EV manufacturing. In Pune alone, the new Detroit of India, more than 38 EV startups have announced building plants. Among them are companies like Triton, VTRO, Dextro Arts, Tork and Attron. The EV sector will likely see Rs 94,000-crore investments in the next five years. Many subsidies from the state government will foster the growth of these industry hubs.

Government actions, e.g., recent moves to amend the Faster Adoption and Manufacturing of Hybrid and Electric Vehicles in India (FAME) II scheme to make electric two-wheelers more affordable, will also speed up the process. Our Prime Minister's Panchamrit plan, recently announced at the CoP 26 conference in Glasgow, will give our EVs a good boost.

MANUFACTURING EFFICIENCY

To become cost efficient against new competitors the Indian car manufacturers will have to reduce their manufacturing costs within the next years. Reducing the manufacturing costs of a car by 50 per cent means reducing the manufacturing hours by half. Electric cars are mechanically much less complex than cars with internal combustion engines. Companies like Tesla have announced they can produce a car within 10 hours. European car manufacturers, like Audi and Volvo, have announced the achievement of similar productivity goals with the next generation of EVs.

More automation, fewer model variants and new production processes, especially in body construction and final assembly, are the key to success. To maintain cost leadership, particularly in the small and mid-size car segments, Indian automakers will have to rebuild their factories over the next few years in order to remain competitive.

Industrial service companies can support along the journey – whether through the engineering and operation of autonomous driving transport systems, the introduction of modular assembly solutions for door trims and other car components, or cloud-based IT applications for products that replace traditional hardware on the lines.

In EV factories, the following areas are particularly suitable for outsourcing:

- Pre-assembly of batteries and cooling systems
- Partial assembly of vehicle components such as door panels
- Maintenance and supply services
- Battery system audits and battery disposal
- Logistics and crating services
- Automation of plant systems

INFRASTRUCTURE EXPANSION

By 2030, more than 10 million EVs will populate India's streets. But for them to be a real alternative to ICE, they need a nationwide charging infrastructure, including charging stations, battery swapping centres, chargers and the entire supporting ecosystem. Otherwise, the EV race will head toward turtle speed.

The Delhi-Chandigarh highway is the first highway in the country to be equipped with 20 solar-powered charging stations for e-vehicles. Total charging stations in India increased by 285 per cent YoY in FY22; government initiatives are likely to further the expansion to ~4 lakh by FY26. But we still have a long way to go to set up multiple charging stations and ease e-drivers' fears about the availability of charging stations.

The government has now delicensed the activity of setting up EV charging stations to increase private sector investments and facilitate market adoption.

Technology providers are developing mobile-based applications which shall provide information about the nearest public charging point location, expected waiting for time and cost of charging. But measured against the demand and also against our population, they are only as big as an almond in a big cake. A change of gear in this area is urgently needed.

SAFETY FIRST

Media reports of electric vehicles, especially electric scooters catching fire in different parts of the country have raised concerns among many people: are EVs really safe? Some manufacturers even had to recall their products. The fires may have been due to improper installation of the battery and cooling system, inadequate testing, and perhaps research into adapting to our country's hot climate and potholed roads.

In general, EVs are safe as all EVs undergo rigorous safety testing. The challenge of fire and explosion risk in batteries is being addressed by most EV manufacturers with their efficient and intelligent Battery Management Systems (BMS) which perform the task of cooling, heating, insulation & ventilation of batteries, etc. The certification agencies, Automotive Research Association of India (ARAI), and the International Centre for Automotive Technology (ICAT) do rigorous testing for overcharge, short circuits and vibration.

For some new EV companies, the manufacturing processes have been questioned, especially by veterans from the automotive industry. The automotive industry is known for its high standards, and these should also apply to EV production. Trained professionals in the factories are also a must to guarantee safety.

For most, this is indeed new territory. A battery is seen as a small object that usually doesn't deserve much attention, e.g. under the hood of ICEs or built into phones or watches. But EV batteries are not just that anymore. The battery of an electric car is like a car floor,

with the passengers sitting on top. It can weigh 200-400 kilograms and accounts for up to a third of the vehicle's cost. There will be an increasing demand for technical service specialists in SOPs for battery and cooling system assembly as well as for battery repair end-of-line and end-of-life. Moreover, cell and battery production require new qualifications: Instead of specialists in manufacturing technologies (e.g. welding or assembly), know-how in process technologies (e.g. mixing, dispensing, filling, degassing, glueing) is now needed.

BATTERY LIFECYCLE

India will require approximately 800 GWh of batteries by 2030 to attain 30 per cent EV penetration. To meet this rising demand, we need to accelerate plans to manufacture li-ion cells within the country. Manufacturing of batteries is only the first step; we have to keep the complete lifecycle in the view from error analysis and repair to disposal and recycling.

So far, recycling plants are still in the pilot stage; rapid industrialisation is to be expected. In the coming years, the demand for services for the disassembly of batteries and the recycling of materials will increase significantly.

Specialised service companies that are already implementing pilot plants for the dismantling of batteries or solutions for the safe storage and transport of used batteries can make an important contribution to accelerating the vertical integration of the supply chain with their special know-how.

NEXT LEVEL OF TECHNOLOGY & COLLABORATION

Batteries have made great strides in recent years in terms of their development and cost through a combination of rapid technological progress and scaled-up production rates, but they still need further intelligent development. The focus is on R&D excellence, value chain integration and flexible manufacturing.

The largest lever is the improvement of cell chemistries and design. One challenge is to further optimise batteries to be able to generate more energy per gram of lithium. New electrode materials also offer the potential to improve performance.

At the moment upstream supplies mainly come from Asian cell manufacturers. Original equipment manufacturers (OEMs) are increasingly moving upstream in the supply chain to secure critical battery minerals to accelerate the transition to vehicle electrification and industrial decarbonisation. Recycling batteries should be considered from the beginning. Potentially recyclable materials from electric car batteries may be minor compared to overall supply, but they could play a critical role in helping supply meet demand. This will





be particularly true for lithium and cobalt.

Adapting the manufacturing process holds great potential for cost savings. For example, Tesla uses a single-piece casting design on the Model Y. It not only increases manufacturing efficiency but also increases safety for drivers. Thanks to the casting the cost of each vehicle's rear underbody design decreases by 40 per cent.

In order to make rapid progress, new ways of collaboration are also emerging. In May 2022 Volkswagen and Mahindra & Mahindra Ltd. (M&M) announced that they have signed a Partnering Agreement. Mahindra intends to equip its 'Born Electric Platform' with MEB electric components such as electric motors, battery system components and battery cells from VW. Designed as an open vehicle platform, the MEB electric platform and its components allow car manufacturers to build their portfolio of electrified vehicles, quickly and cost-effectively.

INDIA'S EV MARKET BY 2030

So, what are we going to see by 2030? A recent study by Arthur D Little, titled 'Unlocking India's Electric mobility potential' estimates that more than 30 per cent of vehicles will be electric by then. However, most EVs will be two- and three-wheelers. Passenger cars will grow slowly.

The driving forces for a transformation of the market will be both the advancement of technology and adoption by customers. The growing demand continues to pose major challenges for the industry. It starts with the planning and ramp-up of new plants, continues with the transformation of existing plants, to efficient and cost-effective service models and ends with the supply chain. This is where specialised technical service specialists are needed - with expertise in all aspects of modern factory organisation.

Time to market will be a crucial element for the players. To this end, it is important that the manufacturers focus on their core competencies and outsource other activities. Manufacturing costs of battery cells

and EVs will continue to fall over the next few years. Significant cost components will remain in the shape of wage and maintenance costs.

Even though the development of the EV market is promising, one point should not be overlooked: the relocation of production capacities for combustion engine manufacturing to India will still play an important role in the coming years.

FOCUS ON CORE COMPETENCIES

Manufacturers have a lot of challenges to meet. Therefore, the transformation to e-mobility also results in an increasing demand for industrial services. The main areas where industrial service specialists can support the automotive manufacturers on their transformation journey are:

- Transformation of existing powertrain plants and industrialisation of new technologies, initially in module and pack assembly, later even in cell manufacturing and vertical integration of the supply chain
- Maintenance and operational support in new technologies, especially from new line builders to support fast ramp-up and operational excellence
- Automation and operation of battery module and pack assembly, in-plant battery audit and repair services and production logistics centres for battery packs
- Manufacturing support services in EV car manufacturing, especially fire protection, hazardous management, onsite battery analytics and repair services, cell handling and line feeding
- Greenfield supports services for new players in the Indian manufacturing market to support time-to-market readiness

Leadec has references for testing and large-scale production support, mainly from projects in China and Europe, but also growing interested in the American Big Three. They have mainly shown interest in support services for commissioning and ramp up Engineering, maintenance of new assembly lines, services for pre-assembly, supply logistics and the planning and implementation of special fire protection and emergency concepts, and quality assurance activities which remain at the top of the list.

Our strategy of providing an integrated technical services portfolio, from engineering to manufacturing support and maintenance services, combined with in-plant logistics and battery repair services, gives key players in the EV industry the opportunity to focus on the market introduction and rapid production ramp-up. This allows them to participate disproportionately in the growth of this attractive market and to achieve a pole position for future growth. 

By Gaurav Kulshrestha, Marketing Head and Product Manager, Pioneer India



FUTURE OUTLOOK OF IN-CAR INFOTAINMENT SYSTEM MARKET

A look into what the cars of tomorrow could offer to Indian customers.

There has been a steady increase in the penetration of connected technologies and a significant rise in the demand for connected cars, which has driven a massive transformation in the Indian automotive infotainment market. With several market players working on the application of advanced technologies to make modern-day cars smarter, the in-car infotainment system market in the country is expected to grow multi-fold by the end of the decade.



Gaurav Kulshrestha

THE BOOMING MARKET

In common parlance, the in-car automotive infotainment systems or in-vehicle infotainments (IVIs) incorporate information and entertainment features in a vehicle, including Human Machine Interface (HMI), media connectivity, telematics, radio/audio/video, and Advanced Driver Assistance Systems (ADAS). The advanced infotainment systems enhance the drivers' in-vehicle user experience through the application of cutting-edge



With advancement in technologies and the rising penetration of clean and green vehicles, automotive infotainment manufacturers have been leveraging cutting-edge technologies to enable real-time information flow to make smart cars even smarter.

information and entertainment solutions.

The automotive infotainment market is expected to grow at the fastest rate during the next few years. Globally, the sector is expected to expand to reach \$61.31 billion by 2029 from \$22.01 billion in 2021 – growing at a Compound Annual Growth Rate (CAGR) of 13.9 per cent during the forecast period. The Indian automotive software market is projected to be worth \$890.15 million by the end of 2022 and grow to an estimate of \$1883.36 million by 2027 – a compound annual growth of 16.17 per cent.

THE SMART CARS OF TOMORROW

The infotainment segment in the modern-day smart cars is primarily classified into ADAS & safety systems, body control & comfort system, engine management & powertrain, infotainment system, communication systems, connected services, autonomous driving, HMI application, biometrics system and V2X System. These technologically advanced features can be inducted into all sorts of smart transportation including passenger cars, light commercial vehicles, and heavy commercial vehicles.

Basically, a blend of information and entertain-

ment, infotainment systems in smart cars are designed to deliver information and entertainment through touch screen displays, button panels, and audio/video interfaces. Pairing the infotainment system also provides drivers with hands-free access to emails and messages and also makes hands-free calls.

With advancement in technologies and the rising penetration of clean and green vehicles, automotive infotainment manufacturers have been leveraging cutting-edge technologies to enable real-time information flow to make smart cars even smarter. Innovative strategies have now even made possible communication between nearby vehicles, thereby creating a connected infrastructure. These advanced features can capture real-time traffic flow statistics, maps, infotainment, remote access to emergency services within seconds, detect potholes and speed bumps, heavy rain, fog, and slippery roads and communicate these messages to cars within a radius of three kilometres.

From 3D downloadable maps to notifications on vehicle maintenance, modern-day smart cars come with a series of functionalities that can be operated through mobile applications. Drivers of internet-connected cars have the feature to lock or unlock the car or even stop or start the engine from any remote location.

The infotainment systems in smart cars also include features like Alexa and Siri, which provide customized voice-based assistance features to make the driving experiences better. Through this, basic activities within the car like adjusting AC temperature, opening or closing sunroofs, setting navigation, starting or stopping engines, etc., can be managed through voice command. 

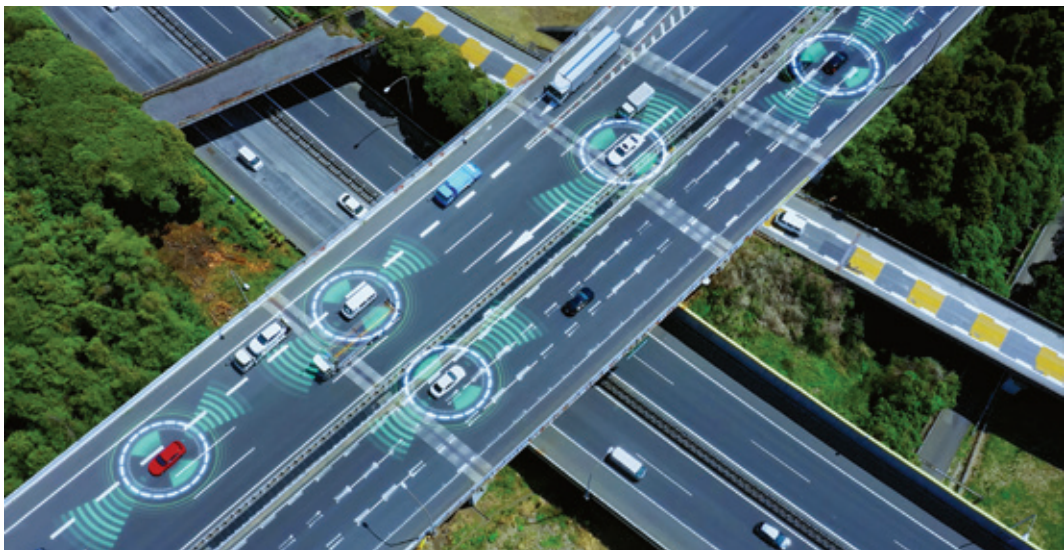

ECONOMIC TIMES PROMISING PLANTS 2022: RECOGNISING FACTORIES OF TOMORROW

The Economic Times recently hosted the second edition of its Promising Plants on August 23, 2022. A glimpse of the grand affair.

India has been on a steady-fast journey to turn into a trillion-dollar economy, and India's manufacturing sector is deemed to be its biggest enabler. As Indian manufacturing stays on its journey to create excellence on a global level, it is important to recognise the efforts and innovations. What platform could do that better than the Economic Time Promising Plants 2022?

The event, in association with Presenting Partner Exxon Mobil, Associate Partners Carl Zeiss India & igus India, and Knowledge Partner BMGI, hosted the red-carpet event for the manufacturing industry on August 23, 2022, in Pune, India.

The event, an amalgamation of discussions and recognitions, felicitated nearly 33 companies from different fragments of the Indian manufacturing sector.

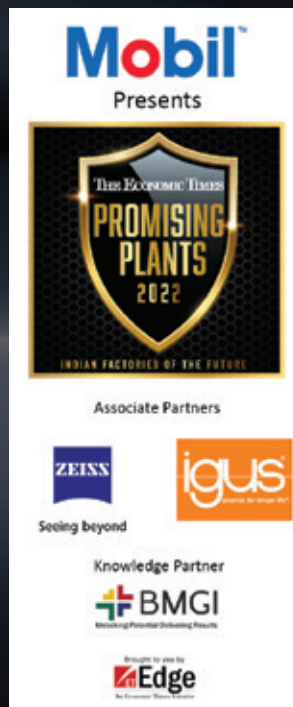

The event kick-started with a chief guest note by RV Sridhar, Executive Director – Downstream, ArcelorMittal Nippon Steel India (AM/NS India). He emphasised, “The universal principle underpinning the promising plants of India is innovation and people, with people being the key. It will be important for plants to have a forward-looking labour policy to ensure employees are a willing partner to one’s business and are on the forefront of giving ideas for growth.”

BUILDING FACTORIES OF TOMORROW DURING PANDEMIC

As the world stood the test of time during the pandemic, Serum Institute of India came through for India and the world. To discuss in depth how SII managed to increase capacity and how they managed to build a plant of the future, next was

a fireside chat on ‘Building manufacturing of the future during Covid-19’.

Discussing how Serum Institute of India managed to prioritise and streamline, in a time when they had an established line of business (of providing measles vaccine), Dr Rajeev Dhere, Executive Director, Serum Institute of India, emphasised, “What helped us greatly was our forward thinking. We don’t go by the generic rules of management. We do not entirely rely on data provided to us by various agencies but look 10 years into the future. Our strategy of looking so much into the future helped us be pre-prepared for any kind of discrepancies without disturbing the ongoing business and entering a high level of manufacturing.” Continuing, he emphasised, “To make a product and design a product, there are two important aspects that





you need – an experienced staff who can judge from the limited data the expected value of that data and skilled handset, which can turnaround your ideas into a technology and a further end-product.”

BUILDING EXCELLENCE IN FACTORIES

The manufacturing sector, while on its journey of recovering from the side effects of the pandemic, has been a reimagining process, updating operations and building resiliency. To discuss in detail the journey of how India can create manufacturing excellence, the event proceeded into a panel discussion on ‘Factories of the future – building manufacturing excellence’.

Panellist Shubhankar Chatterji, Chief Supply Chain Officer, Cummins India, mentioned, “While the pandemic was painful, what it taught us is to completely learn or understand the way you need to react when you are presented with a very disrupted supply chain. It has forced us to think in a different way to challenges presented and evolve from the challenges.”

Adding on, Vasanth T, General Manager – Marketing Deployment (Commercial), ExxonMobil Lubricants Private Limited, during the discussion stated, “In the next couple of decades, the growth story of India is going to be tremendous, as demand and GDP indicators hint. While the GDP grows, there is also going to be an increase in energy demand. Like any other country, we need to focus on how we can optimise energy consumption by making a much better energy-efficient process. While we can’t control much on the consumer side, it is critical that we control it on the industrial side.”

Further, giving perspective on India’s pharmaceutical sector, Rajendra Chunodkar, President - Manufacturing Operations, Lupin, mentioned, “Indian pharmaceutical sector is known as the pharmacy of the world. When on such a pedestal, two things are very important – one, cost optimisation and second – agility. I believe, we have exhausted all the traditional levers of cost optimisation and agility, which is why I believe that digital technologies are going to bring in the next set of cost optimisation and agility

throughout the supply chain.”

Discussing becoming self-reliant India, William Blair, Vice President and Chief Executive, Lockheed Martin India, mentioned, “For us in the defence sector, Aatmanirbhar Bharat is a priority, and we need to get almost 50 per cent of indigenous content out of the box. We are dependent on the aerospace and defence ecosystem to underpin this indigenisation. Hence, it is incredibly important for not just the large companies but for MSMEs in India to be really integrated into the ecosystem and be a catalyst for this process. Further, I really believe, irrespective of the sector, that speed, simplicity and self-confidence will be really important as we look forward to the factory of the future.”

Rounding off the conversation, Amol Nagar, Managing Director, GE Aviation, said, “Regardless of the sector, there is a huge need for skilled people and that is one area where we need to keep investing. Because irrespective of any kind of technological progress, you need the human element, i.e., skilled people who can adopt and adapt to the technological progress and then grow on it.”

THE EVALUATION

With over 200k manufacturing plants in India, the editorial team of Machinist along with knowledge partner BMGI evaluated companies ranging in sectors including oil & gas, plastics, textiles, steel, FMCG, automotive & auto component, aerospace & defence, among others. Based on factors such as manufacturing capabilities, safety, sustainability, productivity/throughput, plant technology & equipment and global competitiveness, nearly 33 companies were recognised as promising plants for 2022.

RECOGNISING & GIVING IMPETUS

The Economic Times Promising Plant 2022 with its felicitations, was only a start to recognising India’s vibrant and dynamic manufacturing sector. With the growing prominence of the Indian manufacturing sector, it acted as the much-needed motivation that the industry needed to do better and to do more. 



FACTORIES OF THE FUTURE 2022



Ashok Leyland



BASF India Limited



Bayer



Bharat Forge Ltd.



Bharat Petroleum Corporation Limited



Cooper Corporation Pvt Ltd



Cummins India



Endurance Technologies Ltd



Evonik Catalysts India Pvt. Ltd.



Faurecia India Pvt. Ltd.



Finolex Industries Ltd.



Force Motors Limited



GE Aviation



Gits Food Products Pvt. Ltd.



Grasim Industries Limited



Kalyani Steels Ltd



Lockheed Martin India Pvt. Ltd.



Lupin



Mahindra & Mahindra Ltd.



Mercedes-Benz India



Mondelez India Foods Private Limited



Motherson Group



Nestle India Ltd.



Procter & Gamble Hygiene and Health Care Ltd.



Rail Wheel Factory



Rolls-Royce India



Serum Institute of India Pvt. Ltd



ŠKODA AUTO Volkswagen India Private Limited



Thermax Limited



Timken India Limited



Vardhman Textiles Limited



Wabtec Corporation (WIPL)



Whirlpool of India Limited

MASTERED HOLEMAKING

Iscar's three-pronged principle of the Multi-Master family was based on the face contact between a carbide head and tool, centring the head by use of a short taper, and securing the head in the tool body by use of a threaded connection.

There are two types of heads which create the cutting section of the Multi-Master tool. The first type is similar in its shape to a multi-flute solid carbide tool but differs in overall and cutting-edge lengths. Increasing the number of flutes on the cutting head makes cutting more stable and productive. The heads of the first type are produced from stepped cylindrical blanks by use of a grinding operation. The heads of the second type are shaped beforehand by pressing and sintering with a minimal oversize. Additional grinding defines the final shape of the Multi-Master head and its accuracy. The heads of this type have only two flutes characterised by high strength. This facilitates increased feeds per tooth in comparison with the heads of the first type. Pressing technology enables the production of diverse complicated Multi-Master geometric shapes.

The head is mounted on a holder that may be an integral body (shank) or an assembly comprised of a shank, extension, and reducer. The holder is a rotating solid tool with cylindrical and conical sections without flutes that allow the evacuation of chips. Multi-Master drilling heads are suitable for relatively shallow holes. This may

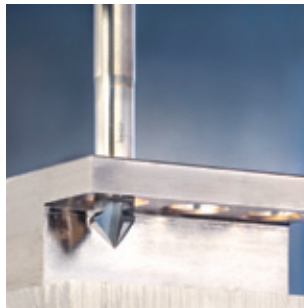

pose a limit in holemaking applications, yet for short-hole drilling when the shape of a part or a work-holding fixture requires high tool overhang, a Multi-Master long-reach tool is more rigid compared to a typical drill with flutes.

Center drilling is one of the most common holemaking operations. Typical tools that perform this task are called centre drills. Iscar's Multi-Master new centre drilling heads have won undeniable popularity by providing increased tool life and

productivity, even under strenuous cutting conditions.

NC spot drills are also commonly used tools. Characterised by their small cutting depth of cut, these tools are primarily used on CNC machines for creating pre-holes that allow precise drilling without the use of guide bushings. For machining shallow holes, the Multi-Master line has great advantages with NC spot drilling heads. A thin web at the head point prevents 'drill walking' during the machining operations. In addition, because of the 90-degree point angle, the heads can be applied to hole chamfering. If the drilling depth does not exceed 1.2 times the length of hole diameter, Multi-Master provides two-flute heads. The heads are suitable for drilling holes on slanted surfaces, featuring versatile cutting geometry, which allows the machining most engineering materials.

ECOLOGICAL: IGUS' FIRST RANGE OF REGRANULATED TRIBO-PLASTICS BEARINGS

Social transformation, responsibility for the environment and changes in the way we use plastics are receiving notice in the industry. For customers interested in more sustainable designs for their moving applications, igus offers an interesting alternative: four new materials made from recycled plastic are available in the new product range iglidur ECO.

At its main site in Cologne, igus develops and tests tribologically optimised high-performance plastics for moving applications: plain bearings, linear bearings, ball bearings, spherical bearings, energy chains, cables, 3D printing materials and plastic-based low-cost robotics. The advantages of tribo-polymers are obvious. They are lightweight, low-maintenance and require no additional lubrication throughout their service life. This is a huge advantage because, in Germany alone, more than a million metric tons of lubricating oil are sold every year, and the majority ends up in the environment. iglidur plain bearing technology can reduce this pollution while increasing the application's service life. With the plain bearing product range made of ECO materials, igus starts even earlier in the product life cycle and uses regranulate to produce new plain bearings.

The new series consists of 97-100 per cent regranulated iglidur materials. To this end, sprue, a classic waste



product in injection-moulding production, can be used. The new plain-bearing product range includes four materials that demonstrate their advantages in a wide variety of applications: iglidur ECO H is especially resistant to temperature and media and can therefore be used in highly corrosive and hot environments. iglidur ECO P offers high mechanical strength with low moisture absorption and is therefore ideal for outdoor use. The iglidur ECO A180 material is suitable for price-sensitive ap-

plications, while iglidur ECO G is extremely robust and versatile.

Like the entire range of iglidur plain bearings, all ECO materials are lubricant-free, and their service life can be calculated online. In 15,000 tribological tests per year, the new ECO series and the other 58 iglidur materials prove how resistant they are to abrasion and wear. Less abrasion means less microplastic pollution and considerably longer service life. If these components are also 'smart', they exactly predict their service life during real operation, regular maintenance and replacement are no longer required. The plain bearing is only replaced when it has to be. This can also increase the service life of the individual components in the application. It is not necessary to routinely replace components that are still functioning correctly.

BESPOKE FIRE RESISTANT POLYMERS



As We get future ready for Electric Vehicles fire resistance for plastic components is gaining more attention.

We at APPL have just the right solution with Bespoke Fire-resistant Grades of Engineering Plastics and Thermoplastics Compounds.

Our High-performance FR Grades are made as per UL94 Flammability Ratings and Halogen free for certain applications.

MOTUL **TECH**

**THE INDUSTRIAL
LUBRICANTS DIVISION
OF THE **MOTUL** GROUP**



SOLUBLE FLUIDS

INDUSTRIAL LUBRICANTS

FORMING OILS

QUENCHING FLUIDS

NEAT MACHINING OILS

HIGH PERFORMANCE GREASES

HIGH PRESSURE DIE CASTING

RUST PROTECTION

CLEANING

motul.com

Motul
119 boulevard Felix Faure
93300 AUBERVILLERS - France
Tel.: +33.1.48.11.70.30
Fax: +33.148.11.70.38

Atlantic Lubricants & Specialities Pvt. Ltd.
301, Ketan Apts., 233, R. B. Mehta Marg,
Ghatkopar East, Mumbai - 400 077
Tel.: +91 22 2501 1960 / 2501 1961
Fax: +91 22 2501 1928

JOBBER EVO SERIES



2 AXES HORIZONTAL CNC LATHE

JE 06 XL/LM
JE 08 XL/LM

FEATURES & SPECIFICATIONS

CAPACITY	JE 06 XL/LM	JE 08 XL/LM
Max. turning diameter	Ø320 mm	
Max. turning length from chuck jaw face *	Ø300 mm	Ø400 mm

* Considering standard chuck size



Large **Ø550 mm** swing over bed diameter



Heavy duty
Hydraulic Turret

8 Station Standard | 12 Station Optional

Spindle bearings configured for
High Axial & Radial Stiffness



Spindle Nose	A2-5
Spindle motor power	5.5 kW (cont.) 7.5 kW (15 mins.)

GUIDEWAY OPTIONS :

XL	Hardened & ground box type guideways
LM	Linear motion guideways



Swivelling Console



Multiple utility options



Easy access to machine accessories & mechanical controls

